

MODERN WIRELESS

February.

THE LARGEST
BRITISH
WIRELESS
MAGAZINE

1/-

VOL. 1. No. 1.

Edited by JOHN SCOTT-TAGGART, F.Inst.P., Member I.R.E.

February, 1923.



No. 1

OF THE GREAT NEW MAGAZINE
FOR ALL INTERESTED IN WIRELESS
INCLUDES PAGES FOR ABSOLUTE BEGINNERS, ARTICLES BY SIR OLIVER
LODGE AND OTHER EXPERTS.

Also articles on How to Receive Broadcasting; Choosing a Receiver;
How to make your Own Sets; How to obtain a Licence, etc., etc.

BUY IT NOW

Take up the sale of
these Radio Sets



The "Cosmos" Crystal Type Radiophone shown in illustration sells

£4 : 10 : 0

complete with aerial, insulators, "leading in" tube, earthing materials and one set of head telephones.

"COSMOS" RADIOPHONES

The thoroughly dependable
radio receiving sets

The "Cosmos" Radiophone illustrated above is a thoroughly efficient Crystal Type Radio Receiving Set. It is made by the firm with a vast experience in every branch of the Electrical Industry, and can be thoroughly depended upon to give satisfactory results within its range.

We are also manufacturing a series of valve type "Cosmos" Radiophones, Note Amplifiers and Loud Speakers. All these types are designed to give perfect results and no technical knowledge is necessary. IT SHOULD BE NOTED THAT WE GIVE FULL PATENT INDEMNITY TO ALL PURCHASERS OF THESE SETS.

Important Note :
All types of "COSMOS" RADIO-
PHONES conform with the
Postmaster - General's Regulations

Belfast
Birmingham
Bristol
Cardiff
Dundee
Edinburgh
Glasgow



**METROPOLITAN
Vickers**
ELECTRICAL CO. LTD

TRAFFORD PARK WORKS,
MANCHESTER.

Send
for
Lists.

Leeds
London
Manchester
Newcastle-or-Tyne
Sheffield
Southampton
Swansea

BURNDEPT Scores Every Time

The Daily Mail

U.S. WIRELESS CONCERT.

HEARD IN ENGLAND.

For the first time on record a wireless concert broadcast from the United States has been heard in England. Mr. Frank Phillips, chief engineer of Messrs. Burndept, Ltd., wireless engineers, of Blackheath, S.E., told a Daily Mail reporter last night:

"About 1.15 this morning (Monday) our chief test-room operator, Mr. J. H. Ridley, was tuning up an apparatus at his house in Croydon, hoping to pick up test Morse signals sent out by amateurs in the United States.

"He was surprised to hear strains of distant music, together with the call No. W.J.Z. repeated several times. W.J.Z. is the call number of the Newark, New Jersey, U.S.A., wireless station. [Newark is 3,750 miles from London.]

"For more than an hour," Mr. Ridley says, "the concert continued and he was able to hear every item of it. An overture by Chopin was among the things played. The wave-length used was 325 metres, which we know is the wave-length used by the Newark station."

While listening-in Mr. Ridley heard no fewer than nine American amateur stations calling to one another. The most distant station he heard was Chicago (4,652 miles from London).

RECORDING BEATEN



H.F. Amplifier Mk. 1

FOR THE EXPERIMENTER.

THIS is an additional radio frequency amplifying unit designed for use in front of the Burndept III or Burndept Ultra IV, or Burndept H.F.I. It is not intended for use in conjunction with other receivers as the scheme of connections is arranged to suit the above named instruments only, and is such that a potentiometer contained in this unit controls the grids of BOTH radio frequency valves.

If YOU own a Burndept III, Ultra IV or H.F.I., purchase this new unit and hear signals you never heard before—even American amateurs if you are lucky—Ridley heard them with precisely this combination.

No. 108 In flat polished case. £10 A.
 No. 108s. In Sloping cabinet. £11 A.

Write for fully Illustrated Catalogue - Price 1/-

All BURNDEPT Valve Apparatus is duly licenced under Marconi Patents for Amateur use in Great Britain

BURNDEPT LTD., London Office & Showrooms: 15, Bedford Street, Strand, W.C.2.
 City Showrooms: 79, Mark Lane, E.C.
 Aerial and Eastnor Works: BLACKHEATH, S.E.3. Bank Buildings, Middle Street, YEOVIL.

236, Argyle Street,
 GLASGOW.

Exchange Buildings,
 133, New Street, BIRMINGHAM

BURNDEPT

61, Bridge Street,
 MANCHESTER.

London Assurance House,
 Bond Place, LEEDS.

WIRELESS APPARATUS



66 POLAR 99

NO EQUAL BETWEEN THE POLES

To Readers of "Modern Wireless"

THIS being the first of a series of "Polar" publicity pages which may appeal to many whose interest in wireless is comparatively recent, we are devoting it to an explanation of our qualifications and policy.

We had acquired a world-wide reputation for Wireless Apparatus before the present boom-days were conceivable.

Our "Polar" installations are in use by the British Post Office, by Colonial Governments and by most of the great Shipping Companies.

Thousands of amateurs are familiar with the distinctive note of the signals from the latest type of "Polar" Transmitter installed at N. Foreland (G.N.F.) and Seaforth (G.L.V.) Stations. By comparing these with other spark signals they can form an idea of the high relative efficiency of our installations.

Our reputation being established in the exacting field of Commercial Wireless, we are now devoting our experience to the service of the private user.

We are producing a wide range of Broadcasting Receivers under the title of "Polar" Radiophones. They are distinguished by their high selectivity, ease of operation, and clear tone. We have made exceptional provision for those in districts remote from a Broadcasting Station, our three-stage H.F. Amplifier having a complete, and unequalled freedom from howling or distortion.

We are also introducing a series of accessories of unique design and quality, several of which are now reaching completion in our works and technical laboratories. An example of these is the new "Polar" Condenser to which we invite your attention on the next page.

THE
RADIO COMMUNICATION CO. LTD
 OSWALDESTRE HOUSE, NORFOLK STREET, LONDON, W.C.2.

BRANCHES :

NEWCASTLE
 17, SANDHILL.

SOUTHAMPTON:
 19 QUEEN'S TERRACE

CARDIFF:
 ATLAS CHAMBERS,
 JAMES STREET.

LIVERPOOL:
 67, DALE STREET.

GLASGOW:
 116. HOPE STREET.

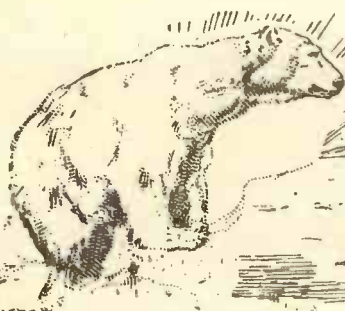

66 POLAR 99

NO EQUAL BETWEEN THE POLES

per mare, per terram



TYPE RA. 36 For Panel Mounting
Price 14/9
Post Free.



Comparison of "Polar" Condenser with .001 Standard Variable Condenser (with ebonite dielectric) of the same range, showing both mounted on one panel.

POLAR VARIABLE CONDENSERS

A new design representing a radical departure from the multi-plate type. The capacity is variable from .0001 to .001 mfd. IT MEASURES ONLY 3" x 3½" x 1"

It is easily attached to any panel, replacing the ordinary variable condenser. It is completely **EARTH SCREENED** by its brass case.

Its uniformly divided engraved scale is approximately a frequency scale. This means that the note of a c.w. signal will change an equal amount for the same degree of movement on any part of the scale. Fine tuning is thus rendered easier.

The scale is 330° in length and very openly divided. It is finished dull black with nickelled markings. The fact that this new Condenser is a "POLAR" instrument is a guarantee of sturdy construction and reliability, but in addition there is a **TWELVE-MONTHS SIGNED GUARANTEE** given with each Condenser.

Made in two forms (see illustrations) for panel mounting or in polished wood case.

CONSIDER THE ADVANTAGES AND THE PRICE and if your dealer cannot show you a Polar Condenser, write direct, enclosing a postal order to



TYPE RA. 38A. In polished wood case.
Price 21/-
Post Free.

THE

RADIO COMMUNICATION CO. LTD

OSWALDESTRE HOUSE, NORFOLK STREET, LONDON, W.C.2

BRANCHES :

NEWCASTLE:
17, SANDHILL.

SOUTHAMPTON:
19 QUEEN'S TERRACE

CARDIFF:
ATLAS CHAMBERS,
JAMES STREET.

LIVERPOOL:
67, DALE STREET.

GLASGOW:
116, HOPE STREET.

Build your own set with Mullard Accessories



23

The wireless components with a world-wide reputation of many years' standing. They will ensure your getting a set which looks well, works well, and "speaks" well.

For receiving vocal and instrumental items you must have

MULLARD "ORA" VALVES

to get the best results

Oscillates Rectifies Amplifies

Specially recommended where good amplification is required.

The "Ora" Valve requires about 3.8 volts on the filament and 30 volts or over between the anode and filament for efficient results.

Standard Price: **15/- each**

IMPORTANT NOTICE

The great demand for Mullard "ORA" Valves and other accessories has compelled us to open much larger works. A greatly increased output is now available.

The Mullard "R" Valve

is now reduced in price from 22/6 to 17/6.

Name and Address.....

To the **MULLARD RADIO VALVE CO., LTD.**
45, Nightingale Lane,
Balham, S.W.12.

Please send me Part Free

Quantity	Description	Price
.....	Telephone Head Sets	21/- per set.
.....	"ORA" Valves Type A	26/- each
.....	Grid A Resistances Type B	16/- each
.....	Anode A or B Resistances	8/- each
.....	BA Condensers	2/6 each
.....	Combined Resistance	5/6 each
.....	Valve Bases and Condenser	5/- each
.....	Valve Sockets with Terminals	1/8 each
.....	Terminal Clips	1/2d. per pair

Name of usual Wireless Dealer.....

I enclose (Cheque Money Order, P.O.) value to cover the cost.

SEND THIS TO-DAY

Mullard Radio Valve Co. Ltd.

45, Nightingale Lane, Balham, S.W.12.

Contractors to H.M. Admiralty,
War Office, Royal Air Force & Post Office

Telephone: Battersea 1068 Codes: ABC (5 Ed) & Benleys Telegrams: "Radiovalve. Wandscom. London"



"ORA"

The Valve for perfect reception

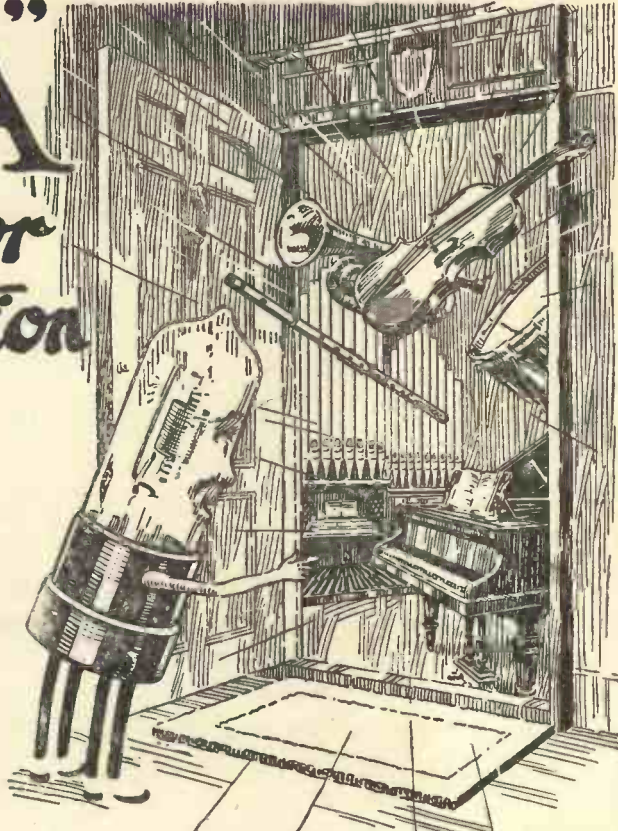

For receiving vocal and instrumental items you must have

MULLARD "ORA" VALVES

to get the best results.

Oscillates **R**ectifies **A**mplifies

Specially recommended where good amplification is required.

The "Ora" Valve requires about 3.8 volts on the filament and 30 volts or over between the anode and filament for efficient results.

Standard Price: **15/- each**

IMPORTANT NOTICE

The great demand for Mullard "ORA" Valves and other accessories has compelled us to open much larger works. A greatly increased output is now available.

The Mullard "R" Valve is now reduced in price from 22/6 to 17/6.

See that you get
"ORA" valves

Mullard Radio Valve Co. Ltd.

45, Nightingale Lane, Balham, S.W.12

Contractors to H.M. Admiralty,
War Office, Royal Air Force & Post Office

Telephone: Battersea 1068 Codes: ABC (5 Ed) & Ben.leys Telegrams: "Radiovalve Wandscom. London"



Please send me Post Free		Price
Quantity	Description	
.....	Telephone Head Sets	2/1/- per set
.....	"ORA" Valves	15/- each
.....	Grid A Resistances	2/6
.....	Anode A or B Resistances	15/- each
.....	BA Condensers, 0009 mid.	8/- each
.....	Combined Resistance	3/- each
.....	Valve Bases with Terminals	2/6 each
.....	Valve Sockets	5/- each
.....	Terminal Clips	1/3 each
.....	8d. per pair

Name and Address.....

To the **MULLARD RADIO VALVE CO., LTD.**,
45, Nightingale Lane, Balham, S.W.12.

Name of usual Wireless Dealer.....

I enclose (Cheque Money Order, P.O.) value..... to cover the cost.

SEND THIS TO-DAY

CONTENTS

"MODERN WIRELESS," FEBRUARY, 1923

	PAGE		PAGE
"Northolt." By E. H. Shaughnessy, O.B.E. M.I.E.E.	3	Double Reaction—A New Development ..	47
Receiving Radio Signals from Electric Lighting Wires. By Philip R. Coursey, B.Sc., F.Inst.P., A.M.I.E.E.	6	An Amateur Wireless Society. By F. Hope- Jones, M.I.E.E.	50
The Transmission of Wireless Waves. By Sir Oliver Lodge, D.Sc., F.R.S.	9	Directional Wireless. By J. Robinson, M.B.E., Ph.D., M.Sc., F.Inst.P... ..	52
A 4,000 Mile Receiver. By L. Vizard ..	11	How to Make a Simple Broadcast Receiver, Using a Crystal Detector	53
A Two Valve Broadcast Receiver	14	Book Review	57
Valve Receivers Employing Crystal Detectors. By John Scott-Taggart, F.Inst.P.	19	The World's Land Stations—Their Calls and Wave-lengths	58
An Experimental Station at Gerrards Cross	23	Choosing a Broadcast Receiver. By Michael Egan	60
Dual Amplification. By P. G. A. H. Voigt, B.Sc.	25	Wireless Operators and their Careers. By Traffic Manager	62
A Simple Winder for Wave-wound Coils. By C. S. Hall	27	2 XB	63
The Dynatron. By Paul D. Tyers	29	Recent Additions to our List of Experi- mental Call Signs	64
Charging Accumulators at Home	31	Map of European Wireless Stations ..	66
The Sine Wave. By Geo. Sutton	33	Some Constructional Notes	67
A Great New Wireless Invention	35	Times of Regular Transmissions	70
A Conducting Cement	39	Greenwich Time by Wireless	72
The Sinking of S.S. "Hammonia." By A. E. Hunter	40	How I Heard the American Concert. By J. H. D. Ridley	73
A Simple Wireless Telephone Transmitter	42	Patents of the Month	74
The Outlines of Wireless. By Lt.-Col. C. G. Chetwode Crawley, R.M.A., M.I.R.E.	45	Experimental Licences. By E. Redpath ..	75
		Digest of Radio Literature	79
		With the Manufacturers	80
		A Page for the Absolute Beginner	81

"MODERN WIRELESS" is published on or about the 15th of the month.

All correspondence relating to contributions should be addressed to Editorial Offices, Devereux Buildings, Devereux Court, Strand, W.C.2.

Contributions, illustrated whenever possible by photographs and rough pencil sketches, will be gladly considered for publication.

PUBLISHING OFFICE : 3, Bolt Court, Fleet Street, London, E.C.4.

TELEGRAPHIC ADDRESS : Radbooks, Estrand.

TELEPHONE NO : Central 4393.

ADVERTISEMENT OFFICES : Scheff Publicity Organisation, Ltd., 125, Pall Mall, London, S.W.1.

TELEPHONE NO. : Regent 2440.

SUBSCRIPTION RATES.

15/- per annum, post free. 7/6 six months, post free. 1/3 single copy, post free.
Registered at the G.P.O. for transmission by Magazine Post to Canada and Newfoundland.



MODERN WIRELESS



Editor:
JOHN SCOTT-TAGGART, F.Inst.P.
Associate Editors:
PAUL D. TYERS. E. REDPATH
Scientific Adviser:
Prof. G. W. O. HOWE, D.Sc., M.I.E.E.

VOL. I

FEBRUARY, 1923

No. 1

PUBLISHERS' INTRODUCTION

WE make no apology for introducing another journal relating to wireless telegraphy and telephony. Our plans were laid a considerable time before popular enthusiasm for broadcasting began. It was obviously appropriate that we, as one of the two publishing firms exclusively concerned with radio science, should produce a journal which would be backed by a thoroughly competent body of radio engineers, who would be responsible for the technical accuracy of everything contained in the journal.

It has been our policy to endeavour to inspire complete confidence in our publications by the critical examination of their accuracy and the practicability of any apparatus, circuits, or systems described in them. Our endeavour has been to produce authoritative wireless literature. The exclusive publication of wireless literature has necessitated the most careful supervision of everything we have produced. The extraordinary success of our books has encouraged us to believe that there is a class of reader who appreciates the advantage of being able to place the fullest confidence in what he reads.

In conformity with this policy, we have placed the responsibility of the editing of this journal in the hands of a professional radio engineer rather than a journalist, but at the same time readers will see that no pains have been spared in giving readers the benefit of skilful arrangement, good printing, high-class paper, and well-produced illustrations. The advantages of having an essentially technical editor will be

apparent, at any rate to everyone with wireless experience.

These remarks would be quite unnecessary were it not for the fact that there are many new members of the enthusiastic body of experimentalists. To these we are hoping our Journal will have a special appeal. It is far more important for the beginner to feel that what he is reading is authoritative, as he has not that knowledge which would enable him to make a judgment of what he reads. As purely wireless publishers, we cannot refrain from emphasising the responsibility which we feel towards the beginner.

"MODERN WIRELESS" is not being published in any competitive spirit. As a monthly journal we can obviously fill a niche which a weekly paper can never fill.

In conclusion, we would like to say just one or two words regarding advertisements. Anyone who has glanced through these pages will at once appreciate that the revenue to be derived from advertising will be a most important factor in maintaining the high standard with which we consider we have set out. The ability to improve a journal depends very largely on the advertising revenue, and the readers have, therefore, the future of the Journal largely in their hands. The exhortation to readers to mention the name of the Journal when replying to advertisers is so frequently seen that it is often ignored. It means, however, a very great deal to the success of the magazine, and if "MODERN WIRELESS" appeals to you, we ask you, as virtual partners in our enterprise

to mention our paper when communicating with advertisers. You will also assist us by using the same address that appears in the advertisements, as these addresses are frequently keyed to enable the advertiser to tell which advertisement has had the desired effect.

Whenever possible, we would like you to use the special postcard provided at the back of each issue. We believe that this frank statement of hard commercial facts will result in co-operation to our mutual benefit.

EDITORIAL

It is customary, we believe, to mention in the first issue of a new periodical some of the general outlines of policy which are going to be followed. No words are needed to indicate the scope of this journal. A perusal of its pages will show that if its scope is wide, yet the number of text-pages provided (as distinguished from advertisement pages) is far in excess of any similar production published in this country.

It is my intention, and that of my associate editors, to make these pages as useful as possible and technically sound. We shall be pleased at all times to receive contributions of an instructional or constructional nature. It is, however, essential that every constructional article shall deal with apparatus which has actually been made and which has given good practical results. We desire every reader to have the fullest confidence in what he reads. Suggestions as regards suitable articles will be very carefully considered at all times.

The general policy of the paper will be an independent and impartial one. It is our intention to be bound to no Society or Organisation. We desire to keep our hands free to criticise or suggest whenever necessary. We intend to maintain the strictest impartiality in

our attitude towards the wireless industry and we will allow no case of hardship on any section of the industry or on wireless workers generally to go unchallenged. We will at all times welcome the views of our readers of both sections on matters of interest.

We intend to do all we can to support the interests of the experimenter. We may mention that we have always taken the greatest interest in the work of the provincial wireless societies, and we shall be pleased to have their views at any time on matters which concern them.

Certain features, such as Queries and Correspondence, obviously, have had to be omitted from this first number.

It would be as well to mention here that the cover of the Journal will remain the same from month to month, except for the imprint of the date and the contents list, which latter will appear at the foot of the cover.

Next month's issue, which will be on sale on February 15th, will, we hope, be considered an even better issue than the present one. There will be several features in the second number which will make it very useful for reference purposes in the future.

J.S.-T.

NOTES OF THE MONTH

Interference Elimination

The trouble of atmospheric elimination is nearly as old as wireless itself. For many years the radio engineer has experimented either with limiting schemes, such as balanced crystals, or with rejector circuits. We give on page 35 some details of a new invention which has proved to be most successful in limiting the effect of interference. Essentially, it is a development of the original rejector circuit, the success of which depends upon obtaining a low ohmic resistance. By ingeniously introducing a reaction effect into the rejector circuit it is possible to wipe out, to a certain extent, the effect of the positive resistance,

thus producing a most efficient rejector circuit.

The Experimental Licence

We have heard on many occasions that the necessity of obtaining a licence proves a deterrent to many would-be experimenters. However, our readers should not imagine that there is really any difficulty in this direction. The attitude of the Post Office towards the wireless amateur is one which is entirely to his advantage. We are sure that the concessions which have now been made to the amateur, together with the result of our investigations into the whole position which we exclusively publish in this issue will remove any doubt which has heretofore existed.



Fig. 1. General view of the Elwell Poulsen Arcs.

“ NORTHOLT ”

By E. H. SHAUGHNESSY, O.B.E., M.I.E.E.

This article, the first dealing with this new station, has been specially written for us by the Head of the Wireless Section of the G.P.O.

A Post Office Radio Telegraph Station for communication with other stations up to about 1,500 miles distant, to the specification, lay-out, and design of the Post Office engineers, and which is classed as a medium power station, has been erected at Northolt, about three quarters of a mile from the South Harrow station on the Metropolitan Railway. The site is approximately 21 acres in extent, and the buildings have been so disposed to the aerial system as to allow of expansions in the number of aerials, and transmitters to be accommodated. The corresponding receiving service is carried out at a separate receiving and operating station.

The station was designed to have a primary wireless equipment of one Poulsen Arc, and

either a second arc, a valve transmitter set, or a high frequency alternator, but no quotations were received for the high-frequency alternator.

Power is taken from the Uxbridge and District Electric Supply Co. Ltd., and is led by underground cable to the transformer house in which the Company's transformer is placed. The supply is three phase 6600 volts 50 periodicity, and is transformed down to 400 volts for power and 110 volts for lighting. The power plant consists of two main units, two smaller auxiliary units, and one special auxiliary unit. Each main unit consists of a three phase motor driving a 40 Kilowatt direct current generator, the generator being designed to give 80 amperes with a voltage regulation of 300 to 650 volts. The main units were made by The Electric

Construction Co. The generators are arranged so that they can be used either separately or both in parallel for supplying power to the wireless plant.

In order to provide against any possible breakdown in the external power supply, each of the main generators is provided with a pulley so that they can be belt driven. A 70 h.p. Crude oil engine of Messrs. W. H. Allen & Sons, make, with self starter, fuel tanks and cooling tanks is provided and placed at the far

auxiliaries and light the buildings. It will get its power from the engine driven 40 Kw. 500 volt D.C. generator, which will also supply power to the Poulsen Arc generators. The three auxiliary units were made by Submersible Motors Ltd.

The wireless equipment consists of two Elwell Poulsen Arcs, type 25; each is capable of taking 70 amperes direct current input, and supplying 50 amperes oscillating current to the aerial or other high-frequency circuit. The

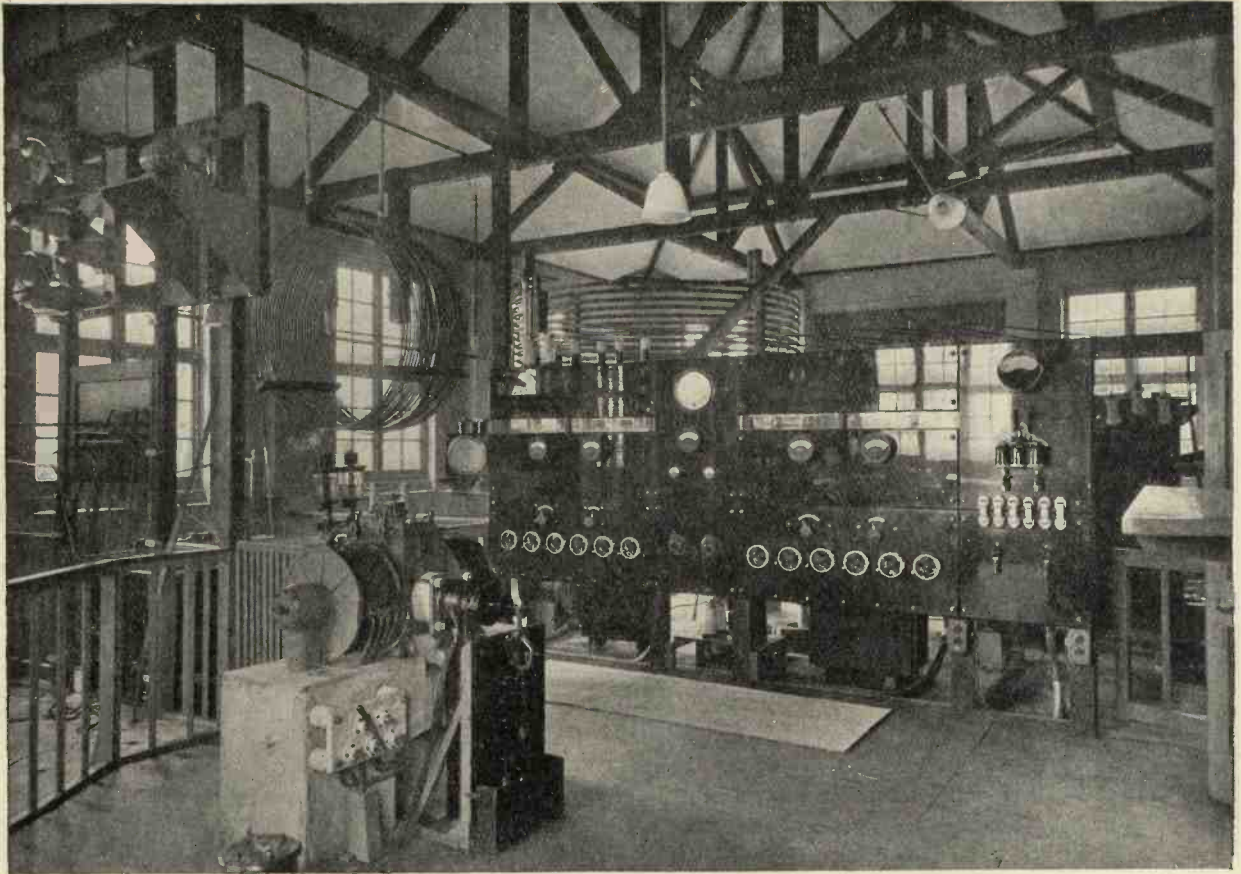

Fig. 2. Another view of the Northolt station showing switch boards and tuning inductances.

end of the power room in such a position as to be able to drive either of the main generators. Each of the auxiliary units consist of a three phase motor driving a 5 Kilowatt 110 volt D.C. generator for supplying power to the arc water circulating motors, air compressor motors, automatic Wheatstone motors, remote control starters, etc.

The special auxiliary unit is a 500 volt D.C. motor driving a 5 Kw. 110 volt D.C. generator. This unit will only be used when the outside power supply fails and will work the

aerial tuning inductance is 6 feet in diameter, and consists of 60 turns of copper tube. Fig. 1 shows the lay out of the two arcs, the aerial tuning inductance, and the leading-in insulator. The leading-in insulator is fixed in the centre of a six foot square panel of plate glass.

The sight feed lubricators on the top of the arcs contain the alcohol which is fed into the arc chamber, where it evaporates and produces the hydrocarbon gas necessary for the efficient and steady burning of the arc. The circuits are arranged so that the signalling may be done

by either of two methods; the first method consists of throwing the arc on to a "back shunt" or local non-radiating circuit for the spacing intervals, and on to the aerial for the marking intervals. The second method consists of slightly altering the "tune" of the aerial and using a "marking" and "spacing" wave. The latter method of working is adopted.

The keys for signalling are worked by electromagnets in the local circuit of a small relay, which latter is operated either by a hand key or an automatic transmitter. Switches are provided for changing from one key to another, and from one system of working to the other system.

An additional aerial tuning inductance of copper tubing 10 ft. in diameter, and a medium power high voltage Dubilier condenser are also provided. With these, the first aerial tuning inductance and the inductance shown hanging from the roof in Fig. 2, the arcs are worked when desired, on coupled circuits. With an input of 70 amperes at 410 volts to the

arc, an aerial current of 50 amperes at 6,850 metres wave length is obtained. The same aerial current at the same wave-length is also obtained on coupled circuits with a slightly increased arc input. The method of working the coupled circuit is by marking and spacing waves.

The aerial is supported on three 450 feet wooden lattice masts, the three masts being placed so as to form an equilateral triangle with

650 feet sides for the aerial. The lead down from the aerial to the buildings is from the middle point of one side of the aerial. The aerial consists of 20 silicon bronze wires 7/19, which are fairly evenly spaced from each other along the lead up side of the triangle, and are bunched together at their far ends, where they are supported by an Elwell insulator attached to the top of the mast. The aerial capacity is approximately .007 microfarads.

The earth system consists of a network of wires radiating from near the leading-in point to under the aerial and beyond to the extremity of the site, about 300 feet beyond the projected area of the aerial. The leading-in insulator is fixed in the middle of a plate glass panel. The actual pull of the up lead it should be noted is taken by two short stout posts, to which insulators, similar to those used for supporting the aerial carrier wires at the top of the masts, are attached.

The station carries out a regular service with Rome, and recently has been employed

on a news service to Halifax, Nova Scotia. As an example of its capability it may be interesting to state that on one day it worked between 11 a.m. and 1 p.m., and between midnight and 2 a.m., disposing of 2,560 traffic words to America.

Arrangements are provided for reception and transmission at the station. Fig. 3 shows the operating table, on which are the Wheatstone automatic transmitter and receiver, and the

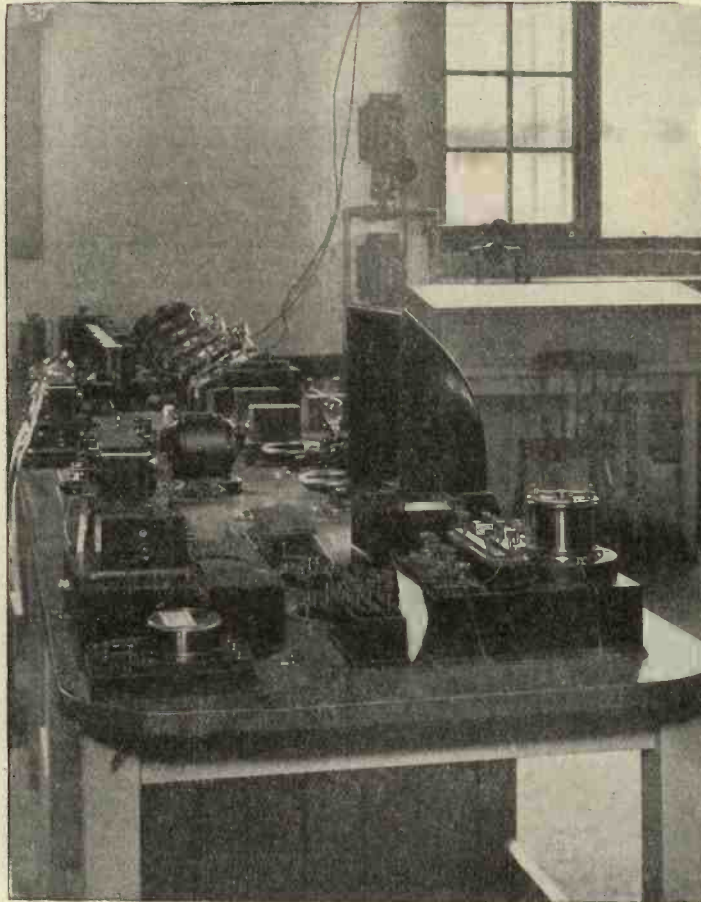

Fig. 3. Operating table showing Wheatstone automatic transmitter and receiver. The Hinton receiver mentioned in this issue will be seen at the end of the table.

wireless receiving apparatus. Normally, however, the station is worked by remote control from the Central Telegraph Office, London. In order to provide for duplex working with the Northolt transmitting station, the reception from distant stations is done on a receiving aerial attached to masts on the roof of the Central Telegraph Office, London, and in that office, adjacent to the receiving gear, is the apparatus attached to the land line, which is used for operating the signalling key at Northolt. The whole

of the power plant, arc wireless plant, masts and aerial at Northolt were supplied by Messrs. C. F. Elwell, Ltd., and the wireless receiving plant and line apparatus by the Post Office Engineering Department. Experimental work on a valve transmitting set is now being carried out at this station by the engineers of the Post Office, and Fig. 2 shows the valve panel that has been erected by them. This figure also shows the 10 feet diameter aerial tuning inductance which is used in connection with valve transmission.

RECEIVING RADIO SIGNALS FROM ELECTRIC LIGHTING WIRES

By PHILIP R. COURSEY, B.Sc., F.Inst.P., A.M.I.E.E.

THE primary function of the antenna, or aerial, used in conjunction with a radio receiving set is the collection of energy from the passing electromagnetic wave so that high-frequency oscillatory currents can be established in the circuits of the receiver. This being the case, it is at once obvious that the aerial can take many forms, provided that in each instance the circuits used in conjunction with the aerial are appropriately modified to suit the individual requirements of the arrangement.

In addition to the conventional forms of outdoor aerial consisting of one or more wires

insulating materials—such as wood, brick, glass, stone, etc.—they are evidently just as capable of inducing high-frequency currents in any metallic objects, wires, pipes, etc., inside a house, as they are in any elevated wires which may be erected outside. The electric lighting wires of a house may become, for this reason, the seat of high-frequency oscillatory currents which can easily be utilised for operating a radio receiver. The length of wiring used in most electric circuits of this nature is generally fairly large, rendering such wiring, in most cases, quite an efficient collector of radio energy.

Until quite recently the only safe way in which use could be made of the radio signal energy collected by electric light wiring, was to switch off the wiring from the supply mains by the main switch at the entry of the supply to the building, but the inconvenience of such a method is obvious. Unless this were done, in addition to risk of shocks, there was the serious risk of a short-circuit to earth through the radio apparatus, since one main of most supply circuits is earthed at the supply station. A special safety device, however, on which patent applications have been filed in this country, under the convention date of the original American patents, has recently been put on the market under the name of "The Ducon." The object of this device is to provide a safety attachment between the power supply circuit and the radio apparatus, so that the above mentioned risks and inconvenience can be overcome, without in any way interfering with the use of the electric lighting or power circuit, for its normal functions.

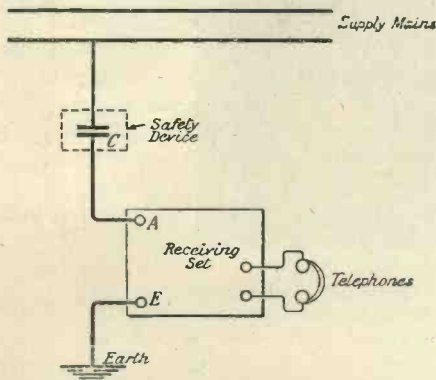

Fig. 1. Schematic arrangement for receiving radio signals from electric light circuits.

supported at some distance above the ground, there are many forms of so-called indoor aerials, amongst which the loop or frame aerial is probably the best known. Since the electromagnetic waves conveying the radio signals easily penetrate all ordinary insulating and semi-

The safety device is fundamentally so designed that no live metal is exposed or accessible when the wiring is being used in conjunction with the radio set, while at the same time no appreciable hindrance is offered to the passage of the radio frequency energy through it to the receiving apparatus. The building up in the lighting circuit of radio frequency currents and potentials of the feeble magnitudes with which we are here concerned, in no way interferes with the proper functioning of the circuit for supplying power and light, and the flow of current to lamps, etc., also does not interfere with the functioning of the radio apparatus to any appreciable extent.

The use of a condenser between the supply circuit and the radio apparatus (Fig. 1) provides all that is necessary for a safety device if the condenser is constructed in such a way that it can safely withstand for indefinite periods the application of the maximum voltage that is likely to occur on the supply circuit, without deteriorating in any way, or heating up at all, and can also be tested at a voltage several times greater than the normal supply voltage so as to provide a reasonable factor of safety. As a general rule, the ordinary house wiring found in this country has considerable capacity to earth, and where the wiring is enclosed in an earthed metallic conduit or sheathing, this capacity will necessarily be further increased. This large capacity renders the tuning of the wires as a whole, to the frequency of the radio signal, out of the question, that is, in other words, the house wiring cannot be tuned up as a whole to the signal wave frequency in the same manner as an ordinary aerial is tuned. The house wiring when used for picking up signals must then generally be regarded as an untuned collector of radio frequency energy, which is handed on to the tuned circuits of the receiver for amplification and detection in the usual manner. In some cases, of course, the capacity may be such that the whole circuit may be tuned up in the same manner as an ordinary aerial, so that the behaviour of the apparatus used for reception in this manner will necessarily vary with the particular circuit that is employed.

Experiments have proved that although one wire of the supply circuit may be definitely earthed it is yet possible to receive signals by connecting the safety device containing the coupling condenser, and the receiving set between that earthed main, and earth. Sometimes even this will give better signals than the "live" main, but this depends upon individual circum-

stances. Which gives the better results can easily be found by reversing the safety coupling device in the lampholder into which it is inserted. This fact that signals can be received from the earthed main of the supply circuit supports the contention that in the majority of circumstances this method of reception makes use only of the wiring in the building, that is, in the immediate vicinity of the lampholder to which the connection is made. Electrically, the circuit may be represented somewhat on the lines indicated in Fig. 2. In this diagram C_1 L_1 represent the tuning condenser and inductance of the radio receiving set which for short wave reception should preferably be connected in series as shown. C is the coupling condenser contained in the safety device between the mains and the receiver, while W_1 W_2 are the two wires of the supply circuit.

For the sake of clearness the connection to the supply main W_2 is shown as made directly to W_2 , whereas, in practice, of course, the general arrangement is to insert the safety attachment into a lampholder. The distributed capacity existing between the two wires W_1 W_2 , and between each of these wires and earth—whether a metal conduit or sheathing, or simply other

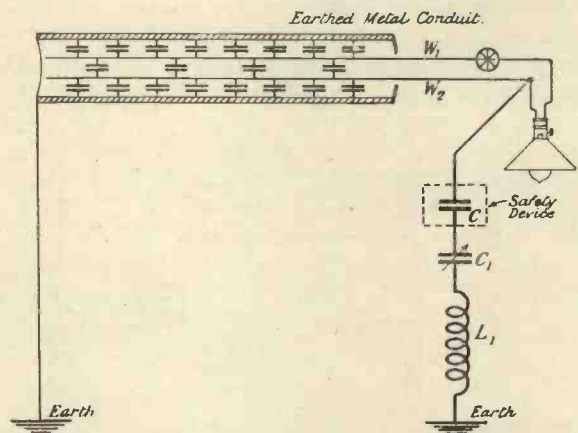

Fig. 2. Illustrating effect of capacity of wiring to earth.

near objects, walls, etc., at earth potential—is represented by the number of small capacities drawn at intervals along the wires, and this capacity serves to close electrically the path of the receiving "aerial circuit." Evidently most of the oscillatory current flowing across this capacity to earth will do so in places in the proximity of the point of attachment of the receiving apparatus to the supply circuit, so that the parts of the wiring furthest from this point of attachment will have less influence on the picking-up of the signals. This effect

entirely limits the reception of the signals in any case to the wiring inside the house, and excludes it from the underground cables under the streets. In those rarer cases in this country where the supply is by means of overhead lines, there will be less capacity to earth, and a portion of the overhead lines may help in collecting the signals.

The complete enclosure of the wiring system of the building in earthed metallic conduit or sheathing does not appear to be detrimental to the use of the wiring for the collection of radio signals, and in such cases one may well ask how it is that the radio energy reaches the wiring at all. The explanation is, I think, again to be found in the capacity distributed along the wires to the earthed conduit. This capacity will be considerable, and will therefore provide a means of electric coupling between the conduit and the wiring inside. Any radio frequency induced in the metal conduit will be transferred to the wiring through this distributed capacity, and thence pass to the radio apparatus. The equivalent electrical circuit is given in Fig. 3, from which it may be seen that it resembles closely a large loop aerial.

Such a circuit should evidently be tuned by a series condenser in the receiving set, rather than with a parallel one, while the selectivity generally possessed by loop aerial circuits is also found, since the tuning of the receiver is generally in

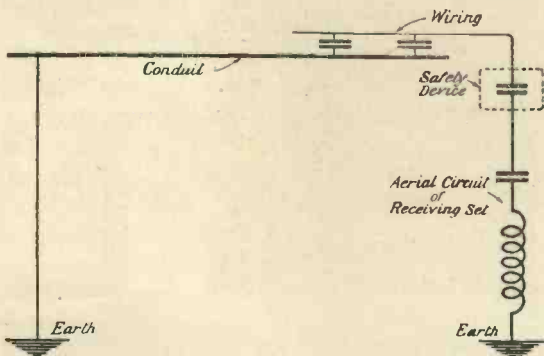

Fig. 3. Equivalent electrical circuit where wiring is in earthed conduit.

such cases very much sharper than it is when using an outdoor aerial with the same receiving set. In many cases it has been found that the tuning is so sharp that the finding of any given station—other than a broadly tuned “broadcasting” station—is difficult unless the exact tuning position is known, but once carefully adjusted and tuned in, the results obtained in such cases are usually particularly good.

Up to the present no mention has been made of any circuit scheme not using a direct earth

connection for the radio receiving set, but many other arrangements are possible. For example, since most supply circuits have one main connected to earth at some point, it is possible to close the radio-frequency circuit to earth by connecting it to the earthed main, though, of

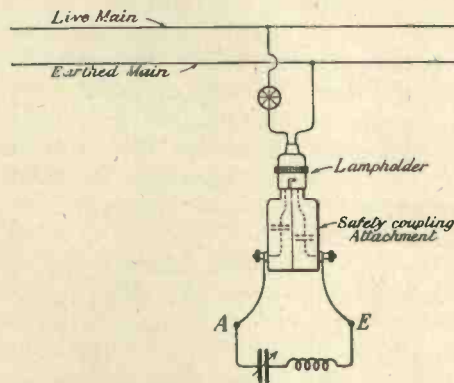

Fig. 4. Receiving signals without an earth connection.

course, a safety blocking condenser must also be used as sketched in Fig. 4. The “aerial” terminal of the receiving set is joined to the live main of the supply circuit, and the “earth” terminal to the earthed main, through the coupling or blocking condenser of the safety attachment in both cases. While capable of giving good results in many cases, this is often not quite so good as when a separate earth connection is employed. There is also a greater liability to pick up disturbances from the supply circuit.

Unless the circuit is a very noisy one, with many sparking motors connected to it, only very slight disturbances are generally heard in the receivers arising from the supply circuit, since the aerial circuit of the receiver being tuned to a radio frequency, offers a high impedance to the flow through it of currents of low, audible frequencies. Since most of the disturbances on supply circuits arise through sparking at motor commutators, it is generally found that A.C. circuits are the quietest to use in the ways here outlined, since the voltage changes are generally on such circuits more gradual, or smoother, than on direct current. As a general rule signals of very good strength—telephone “broadcast” transmissions, amateur transmissions, spark, and C.W. messages—can be obtained from the electric light mains, and from the explanations suggested above, there would seem to be little reason why the supply circuit itself should control in any way the quality or intensity of the reception, if the actual place of the energy gathering is entirely confined to the interior house wiring.

THE TRANSMISSION OF WIRELESS WAVES

By SIR OLIVER LODGE, D.Sc., F.R.S.

The following article has been written exclusively for "Modern Wireless." The continuation will appear in the next issue.

THERE seems to be a good deal of misunderstanding as to how electric waves are propagated from an aerial, not only as regards the distance travelled, and the way in which they get round the curvatures of the earth, but as to their actual mode of propagation, and the process which is going on in the Ether, so that they are able to advance with the velocity of light. For electric waves are not only electric, they are electro-magnetic: that is to say, they have an electric component which is detected at a receiving station by an elongated, or linear, conductor; and they have a magnetic component which is detected by a closed loop or coil of wire. These are the two kinds of aerials in common use, the elevated wire and the closed

loop. One responds to the electric, the other to the magnetic oscillation; and it is pretty well known that these two oscillations are at right angles to each other, and that it is most efficient to have the electric one vertical and the magnetic one horizontal. It may also be known that they have equal energies, and necessarily have equal energies, so that the weakening of one equally weakens the other. The whole progress of the wave depends on the co-existence of these two forms of energy, the electric and the magnetic: and if one stops, they both stop. If one is reversed, the other must be reversed if the

propagation is to continue in the same direction. If one is reversed without the other, the wave goes backwards. And if at any place the one exists alone the wave stops, and at that place you have either an electric phenomenon or a magnetic phenomenon, but not both.

The consequence of all this is that the electric and magnetic disturbances must be coincident in position; one cannot lag behind the other

in a true wave. Whenever one is at a maximum, the other must be at a maximum; which is expressed by saying that they must be in the same phase, as a condition of the progress of the wave.

Yet it is often taught that one is a quarter period behind the other, like the piston and slide valve of an engine; so that when one is at the extremity of

its swing, the other is in mid course; and that the energy oscillates from one form to the other being alternately kinetic and static. For magnetism is due to current or kinetic energy, while electrification is due to static or potential energy; and in ordinary cases they do not co-exist. You may have an electric current, or you may have a charged body. Wherever you have both, you have oscillations and the generation of waves.

But the curious thing is that at the generator the energy really does oscillate from the static to the kinetic form, and back again. Consider

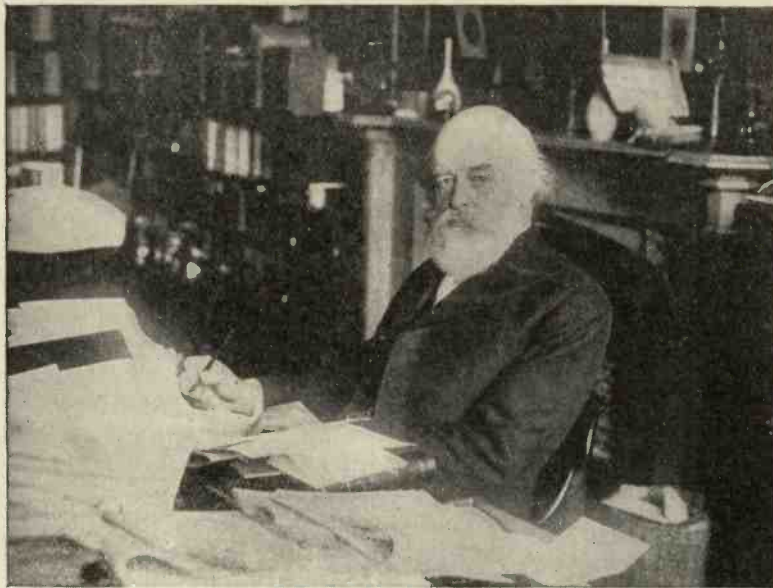

an ordinary aerial, with a capacity area above and below, and a coil in the middle between them. At one instant the upper area is charged positively, the lower area negatively, and there is no current in the coil. At the next instant, separated from the first by a quarter period, the current in the coil is a maximum, and neither area is charged at all. In half a period from the start the current has stopped again, having piled up its momentum in the two areas in the form of a reverse charge, the lower being now positive, and the upper negative. This sets up an elastic strain which recoils back again, generating an inverse current in the coil; which current reaches a maximum, and then expends its energy in recharging the areas in the original way. And so on periodically, the process just recorded is a complete period, and occupies, of course, a very minute fraction of a second, even with the biggest areas.

Hence at the emitting station the electric and magnetic disturbances are not in phase. One lags a quarter period behind the other, just like the slide valve and piston of an engine. A little way off in the Ether the conditions have become different. At a distance of about a quarter wave length the electric and magnetic disturbances have caught each other up, and got into phase. Within that quarter wave length they are not in phase; and, accordingly, the energy in that space oscillates to and fro, alternately travelling outwards and travelling backwards, from and to the source—a pulsation in the Ether—and no true wave is broken off or emitted within the first quarter wave length. But at a certain distance, which was calculated by the great discoverer, Heinrich Hertz, in the light of Clerk Maxwell's theory, some of the energy is flicked off at every oscillation. At that distance the two ethereal disturbances have got into phase. They are coincident with each other, and when that happens the only way in which they can co-exist is to fly along with the velocity of light; which accordingly they continue to do, until their energy is somehow absorbed or

dissipated by conductors. Hertz gave diagrams of the whole process, according to Maxwell's principles, before the year 1890, and thoroughly understood it.

That is why an ordinary alternating dynamo of commercial frequency emits no appreciable waves. The place whence waves would start is a quarter wave length away. And if the oscillations are a hundred a second, the wave length is 3,000 kilometres, or say 2,000 miles, so that the quarter wave length is 500 miles. And the waves from an alternator of 100 a second in the South of England would not begin till about the distance of Aberdeen: that is to say, practically they would not begin at all, though theoretically it is true that every alternator must emit waves of infinitesimal strength. But the waves only become strong and important when the frequency of oscillation is very great; and the higher the frequency, that is to say, the shorter the wave length, the greater is the proportion of energy emitted in radiation. The advantage of long wave length is, not that more energy is emitted for a given horsepower of the sending station, but that the waves are better qualified to overcome obstacles, and to travel to a great distance without so much loss.

That is a digression. What I want to say, further, is that the process of wave-transmission, which has been described and worked out for electromagnetic waves, is essentially true of all waves. The kinetic and static energies are not oscillating from one form to the other, but are coincident and travelling together. Professor Howe has recently pointed out that it is true even of sound waves. At the place of greatest compression or rarefaction we might have thought that the particles would be stationary. So they are in an oscillating column, like that in an organ pipe. So they are in any source of sound, but not so a little distance away: not so in a sound wave as distinct from the alternating pulse which generates a sound-wave.

[To be continued.]

NEXT MONTH'S ISSUE OF "MODERN WIRELESS"

The next number of "Modern Wireless" will be dated March, 1923, but will be on sale on February 15th. It has been decided to keep the cover design standard; the only difference as regards the cover will, therefore, be the imprint of the date and the contents, which latter will be indicated at the foot of the cover.

Next month's issue will be considered even better, we believe, than the present one. For obvious reasons we cannot publish in advance the contents of the March issue, but we can assure you that it will be well worth buying. With each copy will be presented a large map of European wireless stations with their call-signs. This map will be invaluable to all who listen in.

May we remind you again that you will be helping us, as well as yourselves, by using the special postcard at the back of this issue when corresponding with advertisers. The expenses of producing a Magazine of this quality are very high and are largely borne by the revenue from advertising. We intend to make "Modern Wireless" take its place as the best advertising medium, as well as the best journal from the point of view of text contents. Will you therefore kindly indicate, when sending orders or enquiries to advertisers, that you have seen their announcement in "Modern Wireless."

A 4,000-MILE RECEIVER

By L. VIZARD.

IT is up to every amateur who has a set which performs its duties well, to give a description of his apparatus, and for that reason the writer is giving this short account of his own station. There will be many, no doubt, who will think this set a "wash-out," but there may also be some who will benefit by it, and it is for those that this article is primarily intended. From his own experience, the writer recommends every beginner to start with a simple loose coupled crystal receiver, if he wants to know how a wireless set works. Valve circuits are full of pitfalls, and perhaps not so easy to work as some of us are led to believe.

It is a long while ago, but the writer can well remember the excitement there was over the first aerial—a piece of 36 S.W.G. copper wire from the bedroom window to a clothes-prop in the garden. The loose coupler was a huge piece of apparatus, nearly as large as the room in which it resided. But the signals—what strength—not a sound of one for a whole week, until one night, accidentally, the correct adjustment was found, and very faintly, the Eiffel Tower sending time signals could be heard. With the advent of the valve, nearly all the little troubles the pre-war amateur had to contend with do not exist, because the valve makes up for losses in efficiency. But as was said before, many worse troubles come along and are sometimes not confined to the beginner alone, but affect the poor fellow next door who is trying to hear the Dutch concert through our oscillating valve.

The set about to be described works on a circuit known as the "tuned anode" circuit, although by a simple double pole throw switch it can also be used as a simple valve detector circuit. It is proposed to give no details in terms of inductance and capacity because they are misleading, but sufficient information to enable anyone to build a similar set or to adapt a crystal loose coupler. Referring to the figure, 1a is a diagram of a simple crystal receiver with four points marked A, B, C, and D. Without

altering our receiver in any way, it is quite easy to see, by studying Fig. 1b, how to add a valve at the four points marked. From "A" take a lead to the grid terminal of the valve, from "B" to the plate, from "C" to the positive terminal of the high tension battery, and from "D" to the negative terminal of the accumulator

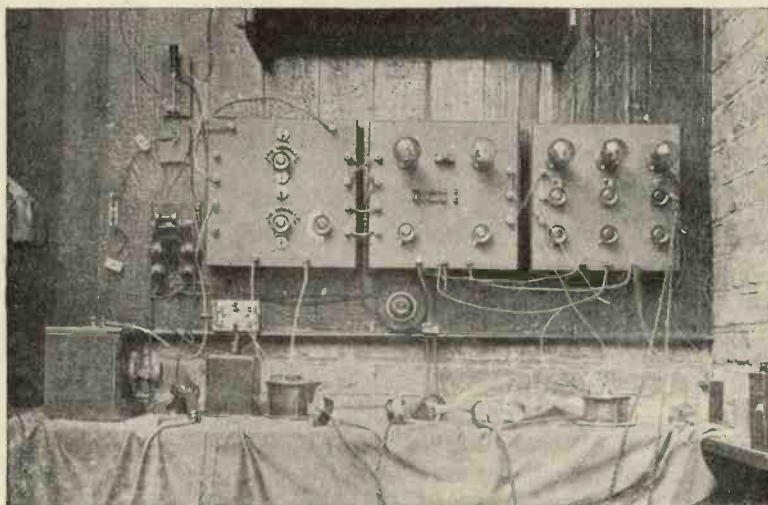

Showing the general arrangement of the receiver, constructional details of which are given in the following pages.

that lights the valve and also to the negative terminal of the high tension battery. A filament resistance "R" is provided for regulating the current supply for lighting the valve, and the only remaining thing to be done is to put on the 'phones and "listen-in."

It was stated previously that the circuit used was the "tuned anode" circuit, and it is essential that the anode circuit is in tune with the Aerial circuit, or the set cannot function efficiently. Referring to Fig. 1b again, the anode coil must be tuned to the wave length of the signal that is being received by the aerial. The most satisfactory way to do this is to split up the anode coil into two portions. One portion is only of sufficient size to allow

sufficient coupling, and the other portion is of any desired size, according to the wave length it is wished to tune to, and is tapped at convenient intervals. The two are then joined in series and form the anode circuit of the valve. Much has been said lately about the unit system, and the writer can say from experience that it is the easiest and most efficient way of building up a receiver.

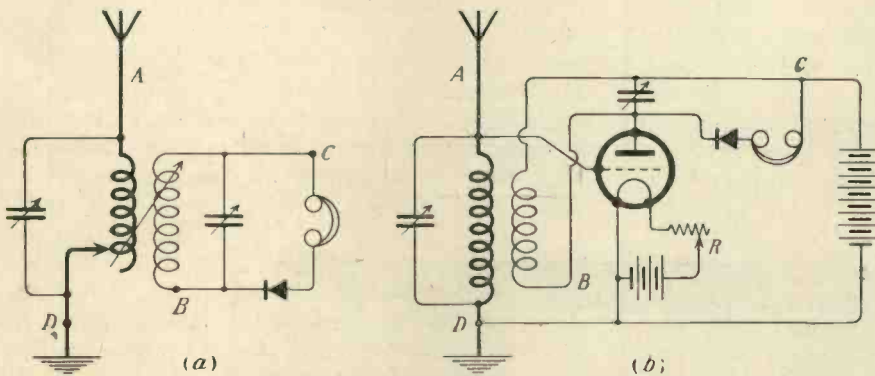

Fig. 1. The basic circuit employed, illustrating how the valve is added.

The receiver about to be described consists at present of three units—the tuner, the detector, and the amplifier. The general layout of the station can be seen from the accompanying photograph. The three units consist of polished mahogany boxes, 12 ins. square and 5 ins. deep., and all fittings are on ebonite which forms the tops to the boxes. The tuning coils are wound on ebonite formers, 3½ ins. in diameter. Coupling is obtained by a ball reaction coil which is capable of rotation in the A.T.I. The aerial coil has eleven tappings, and the anode coil has ten tappings, and four dead end switches divide each of the two coils into three distinct coils for short, medium and long wave work. By referring to Fig. 2, which shows two switches, the method of connecting up can easily be understood. The switch "S" consists of two pieces of brass, of any convenient shape, which do not quite touch. A metal plug is used to short the two portions, thus completing the switch.

For short wave work two tappings are taken at eleven and twenty-four turns respectively. Then comes the dead end switch which brings in the second portion of the coil up to the tenth stud. Stud three is tapped a ¼ in. down the coil and the remaining tappings—taking in a few more turns at each one than the last—complete the medium wave coil. The distance between

the ninth and tenth tapping should be between ½ in. and ¾ in. The second switch at the bottom of the figure brings in two terminals to which any size coil can be fixed, capable of tuning to the very long waves. The aerial coil is wound with No. 22 D.S.C. Wire. The anode coil is wound with No. 28 S.C.S. wire, and is tapped in ten places. The ball on which the reaction coil is wound is 2½ ins. in diameter and half only is wound with ½ in. winding of No. 36 D.C.C. wire. The first stud takes in the reaction coil only, the second stud takes in ten turns on the anode loading coil, and the third stud twenty-four turns. This is found sufficient for waves from 200 to 450 metres.

Connected to the third stud is the dead end switch, and the remaining studs up to the ninth are distributed over the coil in a similar manner to those of the aerial tuning coil. The last dead end switch between the ninth and tenth stud brings in two more terminals for the purpose of

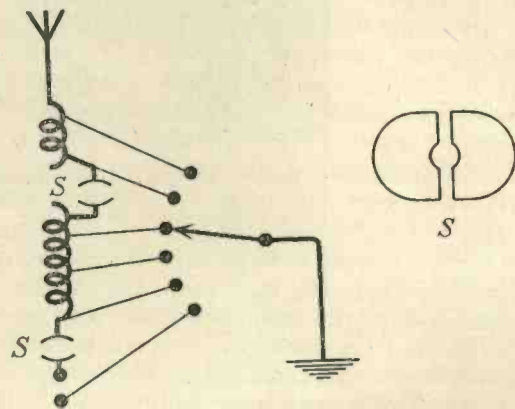

Fig. 2. Illustrating the connection of the special dead end switch.

loading the secondary coil to tune in the long waves. Referring to Fig. 3, the double pole double throw switch when thrown over to position "D," causes the first valve to become the detector working on the leaky grid principle. The secondary or anode coil is not necessarily tuned in this case, but the tappings are a distinct

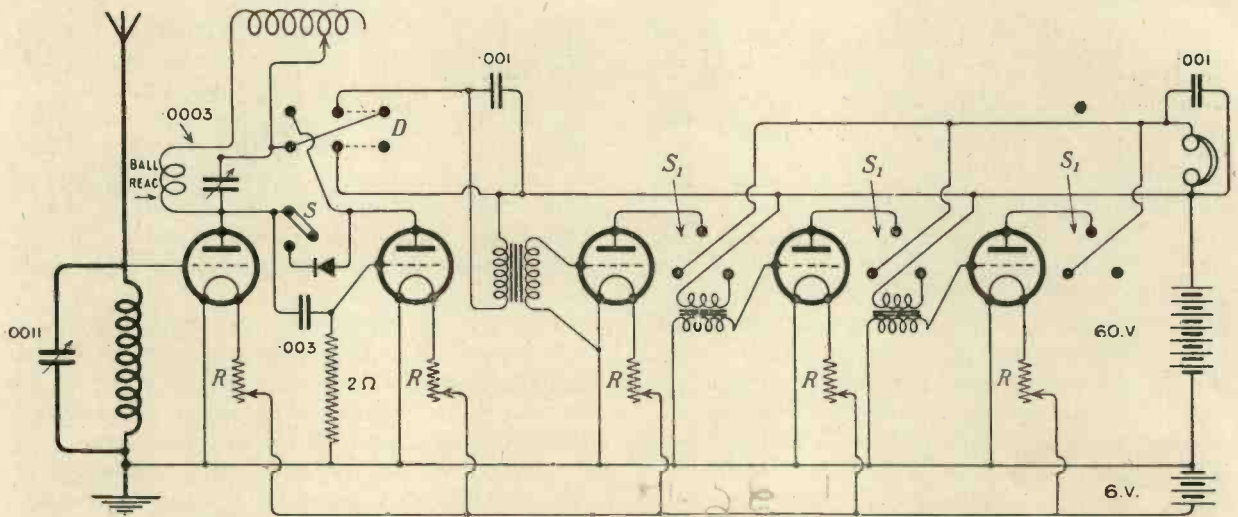

Fig. 3. Wiring diagram of the complete set. The two way switches S_1 control the number of valves in use.

advantage and enable the coil to react over the whole range of wave-lengths.

There are many ways of making up coils for the reception of long waves, but for those who can afford it, a set of De Forest or other type of coil will answer admirably. A holder for these coils can be bought quite cheaply, and a full set of them do away with the use of the cylindrical coils and tapings described in this article, as they would cover the whole range of wave-lengths. When using these coils, a pair are used together, and the larger of the two should be the anode coil. There are many, however, who do not care to go to the expense of these coils, and who much prefer the pleasure of making some up, and the following is an idea which the writer has put to the test. It simply consists of using a set of pancake coils in conjunction with flat slab coils. Pancake coils are very simple to wind and do not require much patience, and for the benefit of those who do not know how to set to work, the following is an easy method.

Procure a piece of round flat brass, about 1 in. in diameter and $\frac{1}{4}$ in. thick. Drill a hole in the centre to which can be fastened any suitable handle, such as an old screwdriver handle. Round the outside drill an odd number of holes about $\frac{1}{8}$ in. diameter which must make a good fit for brass rod of about the same diameter. The number of holes will be about 13 and the length of the brass rods about 4 ins. The finished "spider," as it is called, will be as indicated in Fig. 4, and the method of winding is as follows. Secure the end of some No. 26 D.C.C. wire to a rod, leaving enough to make

connection with, and proceed to wind, in and out, as shown, and when the starting point is reached, it will be found that the wire is on the opposite side of the brass rod, owing to there being an odd number of spokes. The procedure

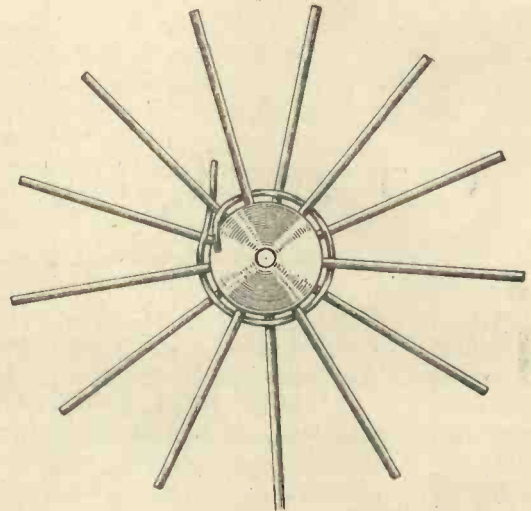

Fig. 4 The "spider" used for winding basket coils.

is then straightforward, layer upon layer until the desired size of coil is finished. A light coat of shellac varnish will set the wire firmly, and when dry, the brass rods can be pulled gently out and the coil is complete.

The other type of coil is less complicated. It is only necessary to obtain a piece of circular wood about 1 in. diameter and $\frac{1}{8}$ in. thick. Fasten this between two discs of wood about $3\frac{1}{2}$ ins. diameter, and put through the centre a spindle with a handle, and mount the whole on some

suitable support. A slit can be cut down one of the larger discs to allow of the free end of the wire being fixed, and it is wound straight on the hobbin, at the same time being supplied with wax or shellac. One side of the bobbin must be easily detachable to allow of the removal of the finished coil. A set of coils wound with No. 30 D.C.C. might be made up in the following sizes. Pancake coils 3 in., 4 in., and 5 in. diameter, and slab coils 2 in., 3 in., 4 in., and 5 in. diameter, and it will be found that these will tune up to about 23,000 metres. The writer simply attaches them to the four terminals provided for loading—using the two coils for the particular wave-length which is desired—and if necessary, one can be laid over the other for further reaction coupling.

Many ways of mounting up the coils will suggest themselves to the reader, but the method described allows of quick change of coil and plenty of experiment for the operator. When used in conjunction with the tapped coils described previously in this article, the approximate wave-lengths of the coils is as follows. Pancake coils up to 5,000 metres, and the rest

up to 23,000 metres, with condenser in parallel. If found necessary, two coils can be used in series in both primary and secondary circuit.

Many ways of assembling the coils will suggest themselves to any who try this circuit, and it is by no means necessary to use cylindrical tapped coils. One advantage of the circuit is that a crystal can be used to replace a valve, but the latter gives slightly better results and is more constant.

Fig. 3 is a complete diagram of the set and it will be seen that it is only necessary to switch out the crystal and switch on the valve which becomes the rectifier in place of the crystal. One, two, and three valves can be used as low-frequency magnifiers and every valve has a separate filament control. Another advantage of the set is that the first valve acts as a high frequency amplifier, and is constant over the whole range of wave lengths, and the fact that the anode circuit is tuned renders the whole circuit extremely selective. On this set signals from the Panama Canal have been received, and all the high power American stations come in quite well on two valves.

A Two Valve Broadcast Receiver

Full instructions for making an efficient but simple constructed receiver.

THE broadcasting receiver described below is very readily made, and will give excellent results on wave-lengths between 350 metres and 500 metres, in other words, over the range of wave-lengths on which the British Broadcasting stations operate. The set may employ two, three or four valves, according to the range required, or the loudness of the speech and music which is desired. A two valve circuit, and certainly a three valve arrangement will work a loud speaker excellently, and four valves will enable broadcasting to be clearly heard within several hundred yards of the loud speaker when the station is within 20 miles of the broadcasting station and when the standard Post Office aerial is used.

The aerial actually employed with this set was composed of two parallel wires each 70 feet long, joined at the end where they enter the

window of the receiving room; 40 feet was the length of the horizontal portion, and the lead-in was 30 feet, the aerial being approximately 30 feet high. The circuit employed is shown in Fig. 1. It will be seen that there is an aerial circuit comprising the variometer $L_1 L_2$ connected across the grid G_1 and filament F_1 of the first valve V_1 . In the plate circuit of this valve is a variometer $L_3 L_4$, the plate P_1 being connected through a grid condenser C of about 0.0002 to 0.0005 μF , to the grid G_2 . A grid leak R_2 of about 2 megohms resistance is connected across the grid G_2 and the positive side of the accumulator B_1 which gives six volts. In the plate circuit of the second valve will be found the telephones T , which may be shunted by a condenser if desired. In most cases the condenser is not an improvement, although it will usually lessen the tendency of the circuits to oscillate of their own accord.

The variometers are constructed in a novel and very simple manner. Figs. 2-7 show the general method of constructing these variometers and the method may be applied to all sorts of different receiving circuits. The first variometer which is used for tuning the aerial circuit to the wave-length of the incoming signals consists of a cardboard tube measuring 4 ins. in diameter and $3\frac{1}{2}$ ins. long (Fig. 2). Two narrow

smaller tube. The method of doing this is shown in Fig. 4. This figure shows the end view of the smaller coil. It will be seen that through the two holes H₁ and H₂ two brass rods B₁ and B₂ are passed. These rods have a 3 B.A. thread on them and may be purchased in foot lengths from manufacturers of screws and terminals. The nuts and locknuts N₁ and N₂ are now screwed on to the brass rods B₁ and B₂ so that the tube T is firmly secured. Additional nuts N₃, N₄, N₅, and N₆ are now fitted as shown. The nuts N₃ and N₄ are for the purpose of taking a wire lead, while N₅ and N₆ are for fitting a handle for rotating the inner coil within the outer coil as will be explained later.

The next thing to do is to wind the smaller coil with 24 turns of No. 26 double cotton covered copper wire. Half a pound of this may be purchased, and will come in useful for making other sets later. Not more than 100 feet would actually be needed for the present set. The method of winding is as follows (Fig. 5). Starting at one edge at a point P₁ a couple of holes are made in the tube, the end of wire is passed in and out once or twice through these holes, the end being finally bared and secured between the terminals N₁ and N₂ inside the tube T of Fig. 4. After having wound 12 turns the wire is lead off so as to miss the nut N₁ on the outside of the tube and a second set of 13 turns is wound so as

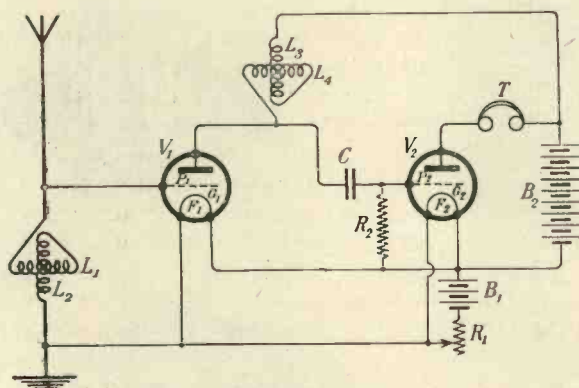

Fig. 1. The two valve circuit.

slits ending in a $\frac{3}{16}$ in. hole are cut with a pen knife in the cardboard tube as shown in the diagram, the two holes being directly opposite each other and about $\frac{13}{16}$ in. from the top end of the tube. Fig. 3 shows a second cardboard



The photograph illustrates the receiver with two extra amplifying valves.

tube $3\frac{1}{2}$ ins. diameter and $1\frac{1}{2}$ ins. long. This cardboard tube has two holes H₁ and H₂ bored in it with a point of a pair of scissors, the holes being directly opposite each other.

Having cut these two tubes to the required size, the next thing to do is to fix spindles to the

practically to fill the remaining half of the tube. The end of the wire is now secured through two holes P₂ (Fig. 5) at the opposite side of P₁; the end of the wire is now fastened between the terminals N₇ and N₈ of Fig. 4, after having been bared. Fig. 6 shows the final inner coil, indicat-

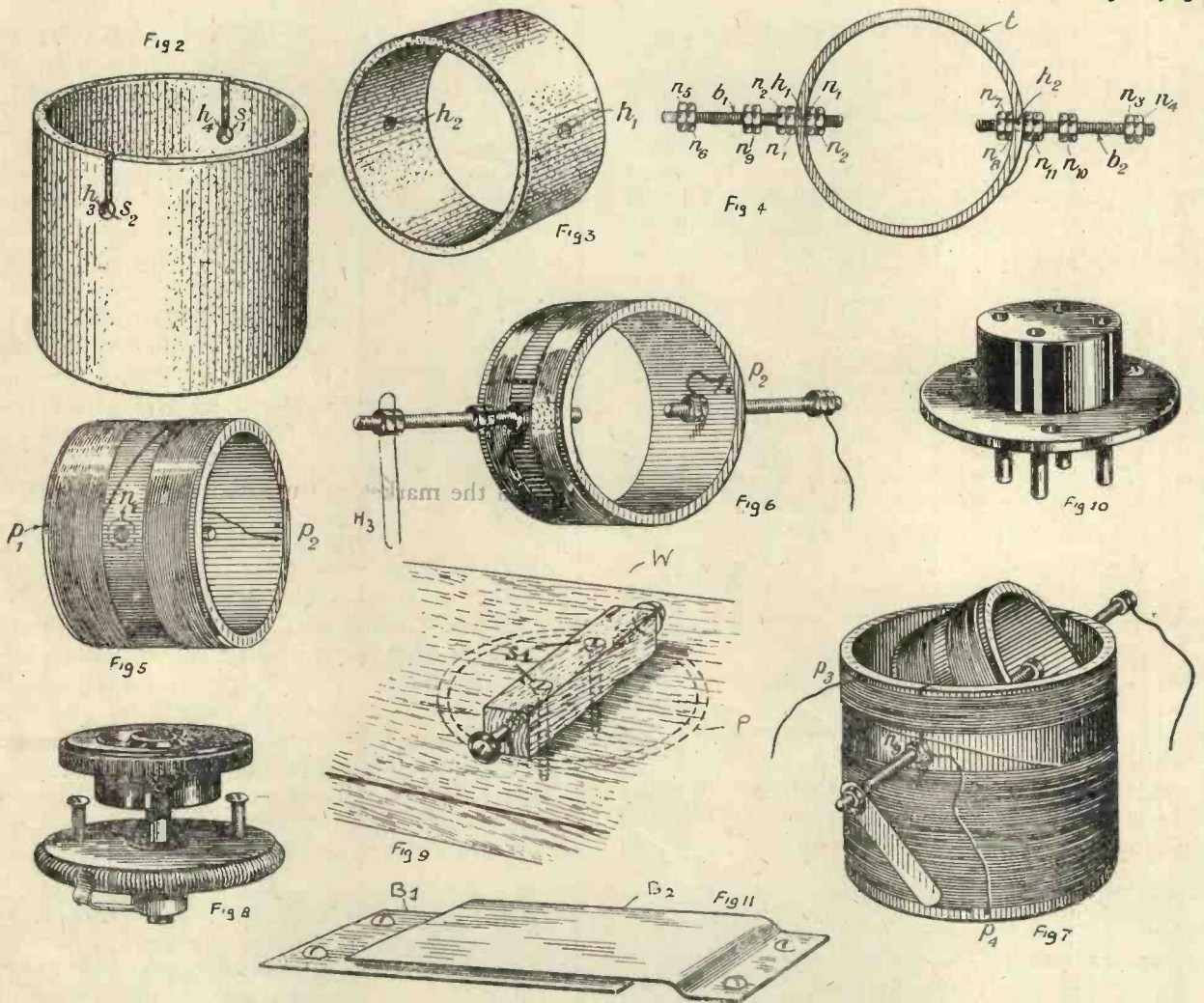

Figs. 2—11. General constructional details of the receiver.

ing how each end of the coil is connected to one of the spindles. A handle H₃, consisting of a piece of wood or cardboard measuring about 2½ ins. by ½ in. is secured between the last two nuts on the left hand side.

Mounting the Inner Coil

The next step in the construction of the variometer is to slip the inner coil within the outer one. This is done by slipping into position the left hand spindle in Fig. 4 down the slit S₂ of Fig. 2, so that the hole H₃ has the nut N₉ on one side and the nuts N₂ and N₁ on the other side of it. Similarly the right hand spindle of Fig. 4 is forcibly pressed down the slit S₁ until the spindle passes through the hole H₄ which has the nuts N₁₁ on the one side and the nuts N₁₀ on the other. These two sets of nuts on each side should be at such a distance as to allow the inner coil to rotate comfortably within the outer

tube without moving too freely, i.e., so that the coil when moved to a certain position stays there. Having got the inner tube mounted within the outer one, the latter may now be wound with 25 turns of No. 26 double cotton covered wire. The arrangement of the turns is shown in Fig. 7. This figure really illustrates the second variometer, but the first differs from it in respect of the number of turns.

There are 10 turns wound above the holes which act as bearing for the spindles supporting the inner coil and 15 turns are wound below this hole. There are two ends to this outer coil winding, namely, P₃ and P₄. The end P₃ is taken as the input terminal or the beginning of the variometer; the end P₄ is bared and connected between the terminals N₉ of Fig. 4. A sufficient amount of wire should be allowed in order that when the variometer coil inside the outer tube is turned round to

180° there will be no pulling on the point P4. The output terminal of the variometer is marked P5.

The Second Variometer

The variometer between the valves is built in exactly the same way as the first variometer, but dimensions are slightly different. It will suffice, however, if the following particulars are given. Height of outer tube, $3\frac{1}{2}$ ins. Diameter, 4 ins. Depth of bearing holes (H3 and H4 of Fig. 2), 1 in. Inner coil has a diameter of $3\frac{1}{2}$ ins, and a length of $1\frac{3}{4}$ ins. It is wound with 28 turns on one side of the spindle hole and 30 turns on the other. The wire used for this winding is No. 36 double cotton covered, and a total number of 58 turns is used. The outer coil is wound with a total of 107 turns of No. 36 gauge double cotton covered wire, 26 turns being wound above the holes acting as bearings and 81 turns being wound below the holes.

Apart from these figures the construction of the second variometer and its connections are the same as in the first case.

The rheostat is actually screwed to the bottom side of the base board, but the brass rod ending in the ebonite knob passes through the board so that the ebonite knob, by being rotated may be used to adjust the amount of resistance included in the filament circuit. Two terminals will be found on the filament rheostat, one being the beginning of the coil and the other being connected to the contact which moves along the surface of the resistance coil. The rheostat is shown in Fig. 8.

Having made the variometers, the next thing to do is to mount them, together with other accessories and terminals, on a wooden board measuring approximately 26 ins., by $\frac{3}{4}$ in. This board has two pieces of 1 in. sq. wood, marked W1 in the perspective of the completed arrangement shown in Fig. 12. Two terminals, A and B, are fixed to the board at one end. Terminals H T are also provided, and are connected to a high tension battery of about 45 volts when the set is in use. Two terminals L T are for making connection to a six volt accumulator. Two terminals T have connected to them a pair of high resistance phones.

Having fixed the terminals the variometers may be fixed in position. Probably the best way of fixing these variometers is shown in Fig. 9. A piece of wood W measuring about $3\frac{1}{4}$ ins. long and $\frac{3}{4}$ in. sq. cross section, is made to fit tightly into the bottom end of the cardboard

tube P. Having made sure that it will make a tight fit inside the tube the latter is taken away from the wooden piece W which is now screwed on to the base board by means of two screws S1. The ends of the piece of wood W are now smeared with glue or seccotine, and the cardboard tube P forming part of the variometer is forced over the piece of wood W until it lies flat with the board. When the glue dries the variometer will be fairly tightly fixed to the base board, but it is preferable to secure the tube more firmly to the piece of wood W by means of screws S2, passing through the tube. Both variometers may be fixed to the board in this manner.

The next thing to do is to fix the valve holders to the board. Various types of valve holders are on the market and usually consist of sockets arranged in the shape of a type to correspond with the pins on the valve moulded into some insulating compound. The four pins of the valve holders project beyond the insulating material and are intended to pass through the panel or base board of the set. The particular type of valve socket used in the set described here is shown in Fig. 10. This socket may be readily screwed down to the wooden board, holes having previously been made in the wood, to allow the passage of the four pins to which wire connections will later have to be fixed, preferably by soldering. The valve sockets should be arranged in the positions shown in Fig. 12.

The grid condenser is a very simple affair, and consists of two sheets of brass, or even of ordinary tin. The condenser marked C in the wiring diagram Fig. 13 is constructed as shown in Fig. 11. One sheet of metal B1 measures $2\frac{1}{2}$ ins. by $5\frac{1}{2}$ ins. and is held down on the board by means of two screws. A similar sheet of

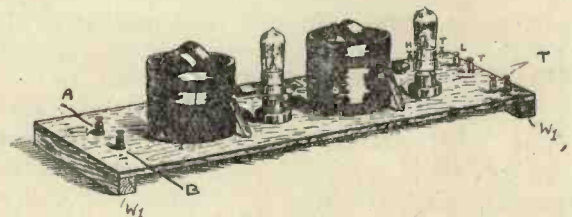

Fig. 12. Illustrating the assembly of the receiver.

metal B2 measuring $2\frac{1}{2}$ ins. by $5\frac{1}{2}$ ins. is bent in such a form that only a small strip will lie flat on the board to which it is secured by two screws. The remainder of the sheet bends over the lower sheet and just clears it, a small gap being allowed. On no account should the plates touch, but they should be brought as close

together as possible without this happening. Connections may be made to the two plates by taking wires to the screws which secure the metal sheets to the board. This is a very crude form of grid condenser, and it will usually be much more desirable to employ a grid condenser which has been bought from a reliable firm.

The set will work perfectly well without a grid leak, but if a bought condenser is used it is desirable to employ a grid leak of about 2 megohms resistance. This may either be made or bought. The leak will usually be mounted between two spring clips, consisting of two pieces of angle brass. These clips can be bought

shape of a kite and the grid socket is the apex of this kite.

The terminal B is connected to the other end of the variometer to which end a lead is taken to the negative L T terminal, which is connected to the negative side of the accumulator. The plate socket pin, which is diametrically opposite to the previously mentioned grid pin, is taken to one end of the second variometer. A connection is also taken from it to the left hand condenser sheet. The right hand plate of the condenser is connected by a wire going to the grid socket of the second valve holder. The other end of the second variometer goes to

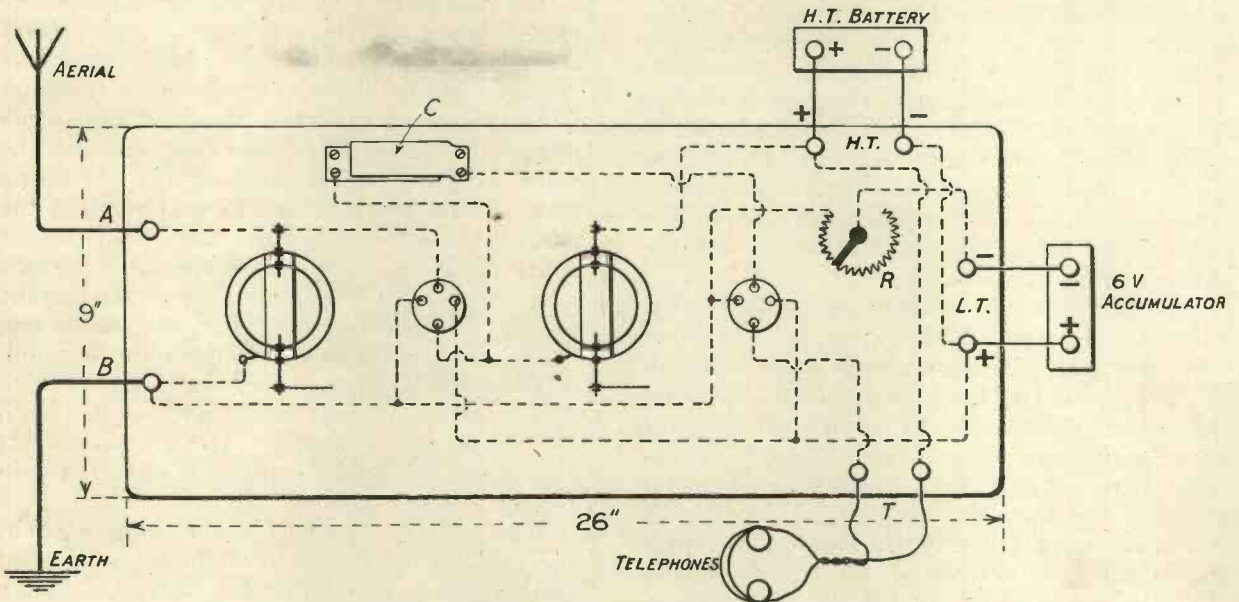

Fig. 13. Indicating the method of wiring the receiver.

from the manufacturers of grid leaks. If a grid condenser is employed, one side of it is connected to the right hand plate of the condenser and the other end of the grid leak is connected to the positive terminal of the accumulator, namely, the positive terminal of the two marked L.T.

When the various component parts of the set have been mounted on the base board, the next thing to do is to wire them up. Those who are familiar with circuits and their meaning will be able to wire up the different parts so as to conform to the circuit of Fig. 1. The actual connections are given in Fig. 13. They are as follows:—The terminal A to which the aerial is connected has a wire going from it to one end of the first variometer coil. This end is also connected to the socket pin of the valve holder which corresponds to the grid pin of the valve. The sockets are arranged so as to be in the

the positive of the H T terminals, which have connected across them a high-tension battery of about 45 volts. This high-tension battery will, in nearly all cases, be purchased.

The plate socket pin of the second valve holder is connected to one of the terminals T, the other terminal T being connected to the positive H T terminal. The filament circuit has now to be provided for, and it will be seen that the left hand filament pin of the first valve holder is connected to the left hand pin of the second valve holder and a wire is then taken to one side of the filament rheostat R, the other terminal of which is connected to the minus L T terminal, the L T terminals being connected to a six volt accumulator. The two right-hand filament pins of the two sockets are also joined together and go to the positive L T terminal.

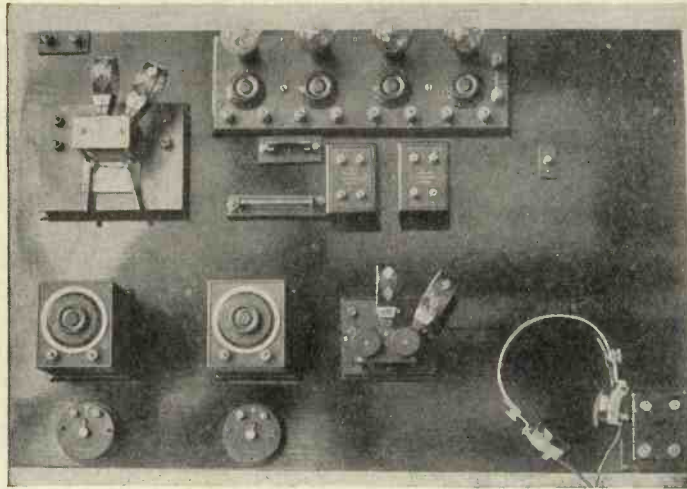

The panel on which the circuits described below were actually tested. Several movable components are not shown.

VALVE RECEIVERS EMPLOYING CRYSTAL DETECTORS

By JOHN SCOTT-TAGGART, F.Inst.P.

MANY consider that the crystal detector is obsolete, and that valves only should be used. This, however, is far from being the case. The crystal detector still has its uses, not only for short range reception of broadcasting, but also when employed in conjunction with one or more three-electrode valves. The valve has many virtues, but as a detector the results are disappointing. When a leaky grid condenser is used in connection with a three-

at least twice as good. This does not mean that an additional valve is necessary because we may employ a crystal detector as the rectifier and the three-electrode valve as the amplifier, the method of using it, however, being made more efficient than is possible in the leaky grid condenser method. In the leaky grid condenser arrangement there is no step-up effect of the low-frequency potentials on the grid. If, however, we use a crystal detector we can use a step-up transformer, which will enable us to apply audio-frequency potentials of considerable magnitude to the grid of the three-electrode valve.

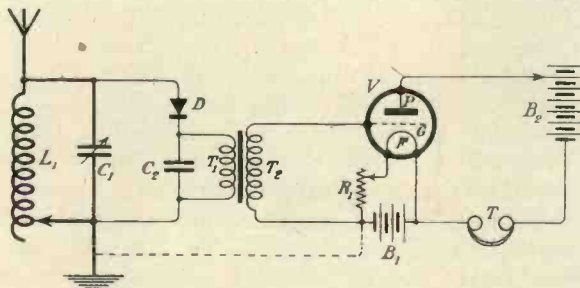

Fig. 1.- Crystal detector with valve amplifier.

electrode valve fairly good detection is possible. If, however, we analyse the action of the leaky grid condenser, we find that it is really nothing more or less than a very poor rectifier followed by a poor amplifier, hence the poor result.

If we separate the two functions of rectification and amplification we are able to get results

Advantages and Disadvantages of Crystal Detectors

The crystal detector is excellent as a rectifier when properly adjusted, and it normally needs no batteries to operate it. Excellent speech reproduction is possible when using a crystal detector, and there is no likelihood of distortion, as in the case of the valve rectifier. The one and only disadvantage of the crystal detector is its liability to get out of adjustment. In cases where it is essential that the whole text of a message shall be received without error, it will usually be desirable to eliminate crystal detectors. It is likewise desirable to eliminate them if the receiving

apparatus is to be operated by persons whose knowledge of wireless is very limited.

In the hands, however, of the better class of British wireless experimenter, and there are thousands of such experimenters in this country possessing a high degree of skill, the crystal

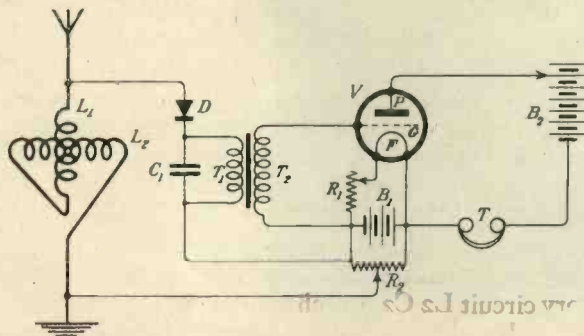

Fig. 2. Carborundum detector with L.F. amplifier.

detector may be made to give very good results indeed. The experimenter's main objects are to obtain clear and loud signals, and the crystal detector will help him to achieve his aims. The writer's own practical experience of these matters has made him treat the crystal detector with a great deal more respect than many writers of these subjects have done. Below are given several circuits which have been found to give exceedingly good results on wireless signals generally, and particularly speech.

A Single Valve Circuit.

The writer has always held the opinion that where constancy over long periods is not important the ordinary single valve detector, without reaction, is not worth the trouble of an accumula-

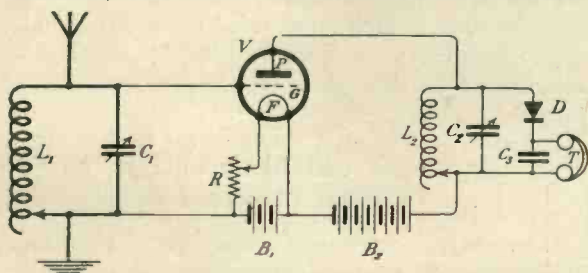

Fig. 3. High frequency amplifier followed by detector.

tor and a high tension battery. It is far better to use a crystal detector by itself. If, however, single valve circuits are to be employed, then the valve should be used in conjunction with a crystal detector, unless reaction may be used, which, in the case of broadcast reception is not permissible. The valve may be used to strengthen the low-frequency currents obtained

from the crystal detector, or it may be used to amplify the high-frequency alternations before rectification.

Fig. 1 shows a very simple single valve receiver in which a crystal detector D is used to rectify the incoming oscillations. The low-frequency currents produced as a result of rectifying the high-frequency oscillations pass through the primary T1 of a step-up transformer T1 T2, the secondary T2 of which is connected across the grid G and the filament F, the lower end of T2 being preferably connected to the negative end of a six volt accumulator B1; a rheostat R1 of about seven ohms resistance is preferably connected in the position shown, the potential drop across the used portion of R1 communicates a small, but useful, negative potential to the grid G which lessens losses through the establishment of a grid current. In the plate or anode circuit of the valve V are the telephones T, and the usual anode battery B2.

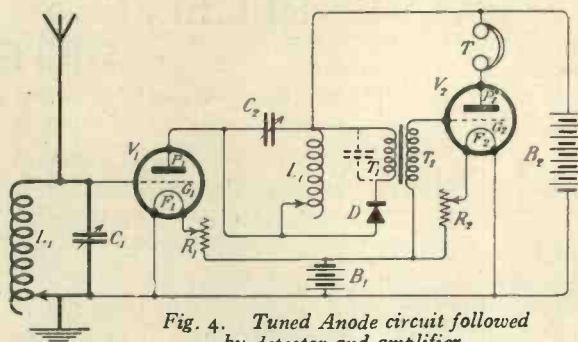

Fig. 4. Tuned Anode circuit followed by detector and amplifier.

The telephones T may be connected on the plate side of the battery B2, and this is necessary if more than one valve is used for amplification. Some small advantage may sometimes be gained by connecting the accumulator B1 to earth, as shown by the dotted lines. The operation of this circuit is simplicity itself. All that is required is the adjustment of the crystal detector D, and the adjustment of the filament rheostat R1 and, if possible, the voltage of the high-tension battery B2. The valve C acts purely as a low-frequency amplifier.

Use of a Carborundum Detector

When a carborundum detector is employed it is necessary to use a potentiometer and battery, the battery generally becoming discharged in a very short time. The need for this extra equipment is the reason why many experimenters do not employ carborundum. If, however, a valve is being used in conjunction with the

crystal it is possible to use the six volt accumulator as the local battery for operating the carborundum detector.

Fig. 2 shows a simple single valve receiver using a carborundum detector D; a variometer L1 L2 is shown in use for tuning the aerial

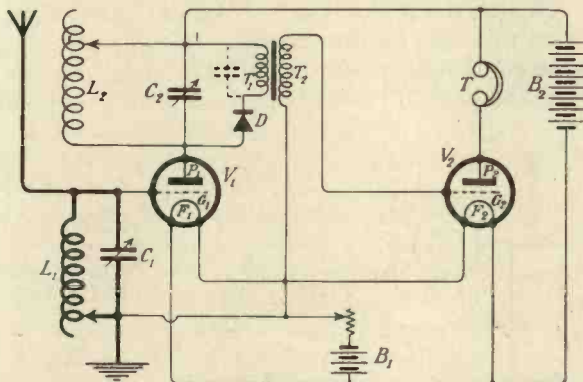

Fig. 5. Reaction circuit with detector and L.F. amplifier.

circuit, but it will be understood in all these diagrams that the initial tuning arrangement may be varied as desired. It will be seen that the lower end of the primary T1 of the step-up transformer T1 T2 is connected to one side of the accumulator B1 which is shunted by a potentiometer resistance R2, the value of which may even be as low as 20 ohms. As the source of electromotive force is an accumulator instead of the usual dry cells, the value of the potentiometer resistance is not material. The sliding contact on the potentiometer resistance is connected to earth as shown. The remainder of the circuit is the same as in Fig. 1.

The chief adjustments on this circuit are the detector D and the potentiometer which governs the E.M.F. applied to the detector. The lower end of T1 is shown connected to the negative side of the accumulator, but the experimenter should try connecting the lead to the positive side of the accumulator, and see which gives the best results.

High Frequency Amplification

We now come to the use of the three-electrode valve as a high-frequency amplifier. This arrangement is particularly useful if the original signals are too weak to give good results with merely the crystal detector. On average signals there is not much difference between the result obtained with high-frequency amplification and low-frequency amplification. In Fig. 3 the aerial oscillatory circuit is connected across the grid G and the filament, a tuned circuit L2 C2, being included in the plate circuit. Across

L2 C2 is a crystal detector D, and telephones T arranged as usual. The circuit L2 C2 is tuned to the same wave length as the incoming signals.

An Efficient Two-Valve Receiver

Fig. 4 shows a receiving circuit in which the valve V1 acts as a high-frequency amplifier, the crystal detector D as a rectifier, and the second valve V2 as a low-frequency amplifier of the rectified current. Perhaps a more familiar combination consists of three valves in which the middle one acts as a detector. In this circuit, however, a crystal is employed instead of a valve, and the results obtained are almost the same. It will be seen that there is in the plate circuit of the first valve a tuned oscillatory circuit L2 C2, which is tuned to the incoming wave length. Across this tuned circuit is the crystal detector D and the primary T1 of a step-up transformer T1 T2, the secondary of which is connected across grid and filament of the second valve. It will be noted that the crystal detector is connected to the high potential end of the inductance L2, that is to say, one side of the crystal is connected directly to the plate P1. In the plate circuit of V2 are connected the telephones T.

Use of Reaction

Fig. 5 shows a somewhat similar circuit to that given in Fig. 4. A circuit tuned to the incoming frequency is included in the plate circuit of the first valve. A crystal detector and the primary of a step-up transformer being

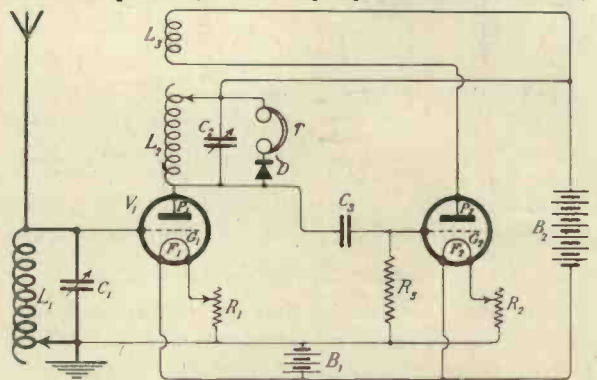

Fig. 6. A non-radiating two valve receiver.

connected across the plate oscillatory circuit. The second valve, as before, acts as an amplifier of the low frequency current supplied by the crystal detector.

It will be noticed, however, that the inductance L2 is now coupled to the aerial inductance L1 so as to produce a reaction effect for the purpose

of strengthening the incoming signals. The coupling between L_2 and L_1 should be critically adjusted or sufficiently tightly coupled when receiving continuous waves. As this circuit employs reaction on the aerial circuit it is not permissible for use in connection with the reception of broadcast items.

Fig. 6, however, illustrates a somewhat similar circuit in which the reaction, instead of being produced on the aerial circuit is produced in the plate oscillatory circuit of the first valve. This effect is obtained by the use of a second valve V_2 . It will be seen that the oscillating potentials across the circuit $L_2 C_2$ are communicated to the grid G_2 of the second valve, magnified oscillations appearing in the plate circuit of V_2 and therefore in the coil L_3 which is coupled to L_2 in such a manner as to produce reaction in the circuit $L_2 C_2$. A circuit of this kind is permissible for the reception of broadcasting, and may also be employed for the reception of continuous waves by coupling the inductance L_3 tightly to the inductance L_2 . When receiv-

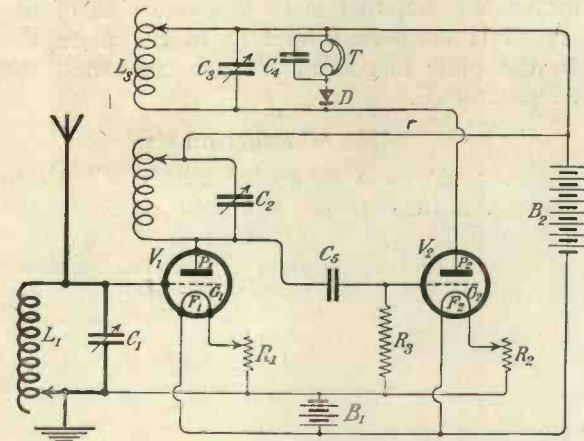

Fig. 7. Receiver with two stages of H.F. amplification.

ing continuous waves in this manner there will, of course, be no radiation from the aerial circuit.

A Highly Sensitive Circuit

The second valve V_2 may be employed as an effective amplifier, and a circuit of this kind is shown in Fig. 7. We have here the detector and telephones connected across a tuned plate circuit $L_3 C_3$ tuned to the incoming wave length, the inductance L_3 being coupled to the inductance shunted by C_2 forming part of what is sometimes called a rejector circuit. It is important when operating a circuit of this kind to see that the first valve does not oscillate owing to the inherent coupling between this circuit and the circuit $L_1 C_1$. Any tendency

for the first valve V_1 to oscillate may be easily counteracted by connecting the bottom end of L_1 , not to the negative side of the accumulator B_1 as shown, but to a point on a potentiometer connected across B_1 . When receiving speech or damped wave signals it is also desirable that the second valve V_2 should not oscillate, and this may be prevented by suitably adjusting the coupling between L_3 and L_2 , or by connecting the bottom end of the grid leak R_3 to a point

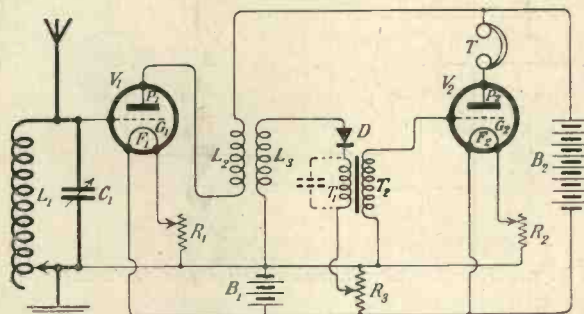

Fig. 8. Two valve circuit with carborundum detector.

on a potentiometer resistance connected across B_1 . In Fig. 7 the condenser C_5 is merely for the prevention of the high tension voltage from B_2 effecting the grid G_2 of the second valve.

Another Circuit

Fig. 8 shows another useful receiving circuit in which the anode or plate circuit of the first valve V_1 contains an inductance coil L_2 either aperiodic or having a natural frequency approximating to that of the incoming signals. A similar coil L_3 is coupled to L_2 as shown. Across L_3 is connected the detector D and the primary T_1 of the usual step-up transformer $T_1 T_2$. The bottom end of T_1 is connected to a variable contact on a potentiometer resistance R_3 connected across B_1 . The lower end of L_3 should be connected either to the positive side of B_1 or the negative, according to which gives best results. The second valve V_2 acts merely as low-frequency amplifier.

Conclusion

From these particulars it will be seen that various efficient circuits may be arranged by employing a crystal detector as the rectifier. Many variations are possible and will occur to the reader. If it is desired to receive continuous waves it will in all cases be preferable to employ another valve as a local oscillator, but to work that valve off the same accumulator and high-tension battery as the other valves.

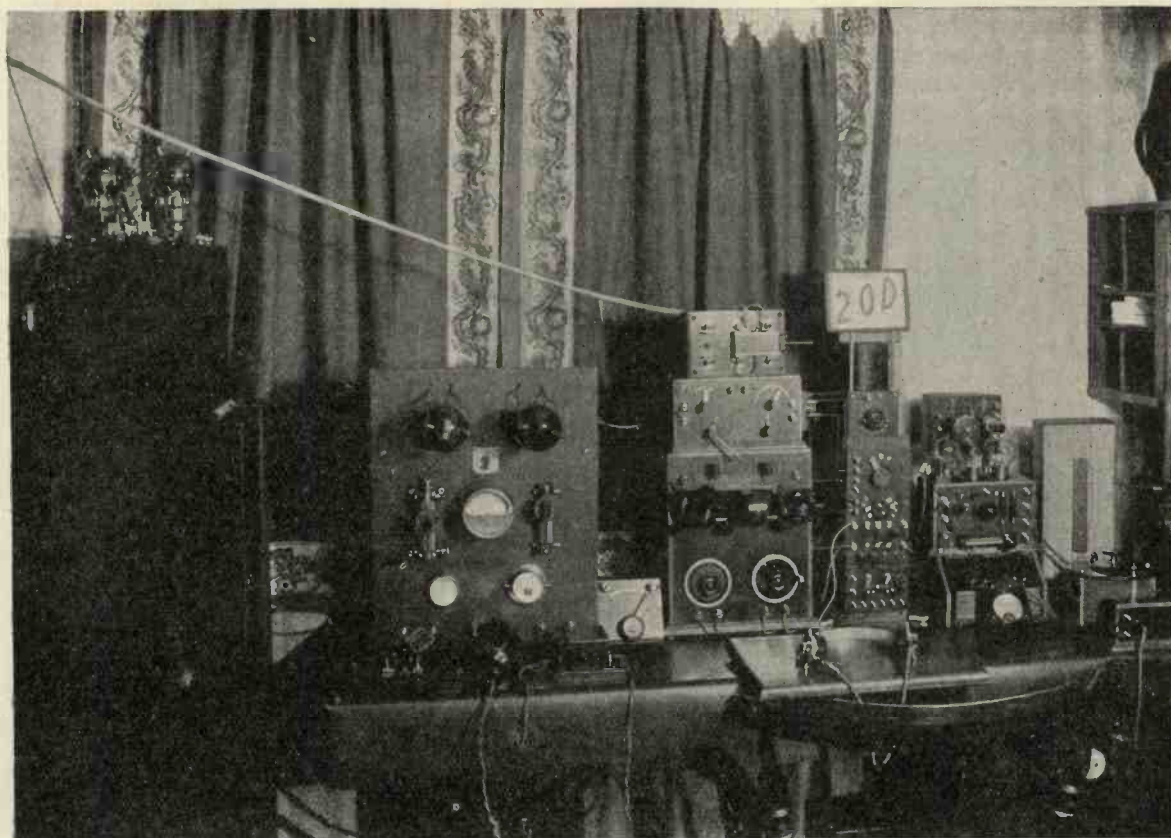

A general view of the transmitter and receiver.

AN EXPERIMENTAL STATION AT GERRARDS CROSS

THE following particulars of a very fine experimental station have been supplied to us by the owner, Mr. E. J. Simmonds, of Gerrards Cross. The first of the photographs illustrates a general view of the transmitter and receiver. The high tension supply is obtained from stepped up and rectified alternating current, the necessary transformers, valves and control rheostats being shown on the extreme left. Behind the transmitter panel are mounted the long and short wave inductances, tuning and grid condensers, radio and audio-frequency choke coils and the modulation transformer. All the transmitting filaments are heated by alternating current, a special system being employed which gives absolute freedom from the A.C. hum. The various high tension condensers, smoothing chokes and filament transformers are placed underneath the table.

The other photograph gives a more detailed

view of the receiver. A balanced circuit tuner is employed fitted with duolateral coils, on the top of which the short wave tuner can be seen. All the tuning coils are wound with Litz wire.

To the right of the tuner can be seen a panel on which are mounted various switches which facilitate a quick change over from transmission to reception and vice versa. The amplifier will next be noticed, and this, again, is fitted with a system of switches which enable any number of valves up to five to be used. The amplifier is so arranged that radio frequency amplification can be obtained by high frequency transformers, reactance capacity, resistance capacity or choke capacity. To the right of the amplifier will be seen the large tuning coil, which tunes up to 15,000 metres, and is fitted with special switches to eliminate dead-end effects. Next to this will be seen the relays which are used for recording purposes, while below these is mounted a high

speed undulator made from an old Morse inker. Above the large tuning inductance is a heterodyne wavemeter which reads from 150 to 20,000 metres, which was calibrated against standard

obtained clearly indicate the skill with which the installation has been made and which is also displayed in its working. As an instance of this, it is sufficient to say that on a radiation of

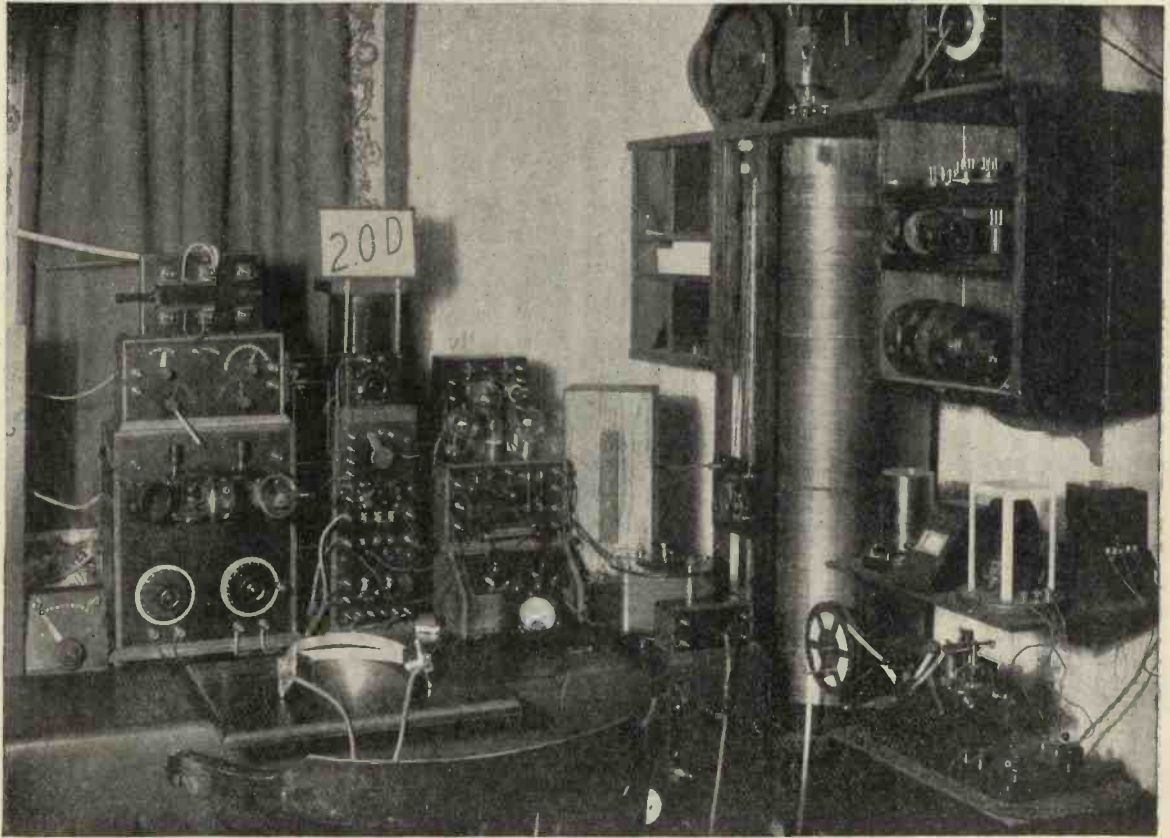

A near view of the Receiver.

inductances and capacities. This wavemeter is checked by the bi-monthly transmission from Eiffel Tower and Lyons.

All the apparatus illustrated has been made by the owner in his home workshop, and the results

.45 amperes, strong C.W. has been heard up to at least 250 miles from Gerrards Cross. It is interesting to note that both photographs were taken by means of artificial light, very long exposures being necessary.

NOTICE TO OUR READERS

WE take this opportunity of mentioning that we are at all times pleased to consider for publication descriptions of wireless stations, whether commercial or experimental. Articles of an instructional or constructional nature will also receive the most careful attention. It is, however, absolutely essential that the apparatus described shall have proved successful in actual operation. Photographs will also be welcomed.

DUAL AMPLIFICATION

By P. G. A. H. VOIGT, B.Sc.

In most amplifying circuits the valve is used to amplify either at radio frequency or audio-frequency. By suitable arrangements of the circuits it is possible for a single valve to function as a high and low-frequency amplifier. The following article explains how one valve in conjunction with a crystal detector may produce results equivalent to those obtained from three valves.

ALTHOUGH many amateurs know that one valve can be made to do the work of two by making it amplify the radio and audio frequencies simultaneously, there are few amateurs who know how to do it, and still fewer who use their valves in this manner.

The principles involved are simple, and the resulting circuits need not be more complicated than the corresponding circuits using one valve for each stage.

As a detector for weak telephony the writer always uses treated galena. This crystal has many fancy names, mostly ending in "ite," and the synthetic variety has a granular appearance. It should be used in a detector in which the moving part is small and very light. For preference, two detectors should be used with a switch, so that they can be set by comparison with one another.

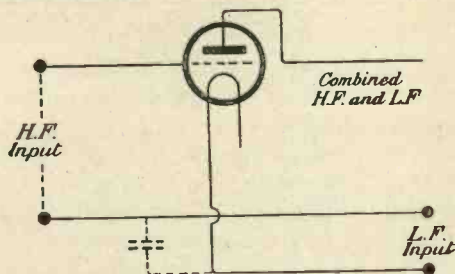

Fig. 1. The principle of dual amplification.

In order that a valve may amplify both HF and LF, it is necessary to superimpose the HF on the LF in the grid circuit.

Fig. 1 gives a diagram of the connections. The LF input is derived from the secondary of a transformer when a valve detector or crystal requiring a polarising current is used, but if a crystal not requiring a potentiometer is used, the LF input may be taken direct from the blocking condenser in the crystal circuit.

The best way of superimposing the HF is by means of a coil coupled to the aerial, but a direct

connection to the aerial circuit itself may be used.

A small condenser across the LF input will generally be necessary to keep the filament and the lower end of HF input at the same HF potential.

The HF voltage is applied to an ordinary HF amplifier by direct connection to grid and filament. In these dual circuits the connection to the filament is opened, and a condenser is inserted. This condenser has a very small impedance to HF currents, and as far as they are concerned, it is as good as a direct connection.

In an ordinary LF amplifier the LF voltage is applied by direct connection to grid and filament; in these circuits the connection to grid is broken, and a coil whose LF impedance is negligible is inserted. The LF input terminals are also shunted by a condenser which will make little difference to the LF efficiency, providing it is not too big (say $.001 \mu\text{F}$.)

The valve now amplifies both HF and LF. If more than one valve is to be used for dual amplifications, coupling capable of dealing with both frequencies must be used. The simplest coupling is the resistance-capacity-resistance coupling, but for LF and short wave-lengths, this coupling is not so good as transformers specially designed for the purpose.

The best dual intervalve coupling consists, therefore, of a tuned HF transformer and an iron core LF transformer, both in series. If the windings of the LF transformers do not have sufficient capacity to by-pass the HF currents, they should be shunted by small condensers. About $.002 \mu\text{F}$ for the Primary and $.001 \mu\text{F}$ for the secondary is generally ample.

The methods of applying the dual voltage to the first valve and passing it on to the next, when more than one is used, have been described. It now remains to describe how the HF is selected from the LF in the plate circuit of the last valve.

One method of doing this is to put another HF transformer in series with the phones, which should be shunted by a by-pass condenser. The secondary of the HF transformer can then be connected to the crystal detector and its blocking condenser.

Fig. 2 gives a single valve dual circuit and crystal detector as described above. It will be seen that it is not more complicated than an ordinary 1 valve HF, crystal and 1 valve LF circuit.

In the circuit shown the batteries are not connected to earth. This is sometimes a disadvantage near lighting mains, because the batteries will pick up the hum, and it will be audible in the phones.

If it is desired to earth the batteries, the best way is to use as HF input, not the aerial coil itself, but a coil coupled to the ATI. If the coil is loosely coupled, it will have to be tuned, but if it is tightly coupled, this will not be necessary.

Magnetic reaction can be obtained by coupling the plate coil to the aerial coil. With some designs of transformers this is not easily done, and then capacity reaction, which is equally efficient and generally more convenient, should be employed.

To get capacity reaction, either the HF transformer or the aerial coupling coil must be connected so as to reverse the voltage. A very small variable condenser (.00005 μ F maximum value) should then be connected across the valve and either the HF transformer or the aerial coil so that there is the amplification and reversal due to the valve, and one other reversal of voltage between the points to which the reaction condenser is connected.

The use of a tuned coupling between valve and crystal brings in an adjustment which can be eliminated at the expense of selectivity by using an aperiodic coupling whose efficiency as valve to crystal coupling is very high, even on short waves. Such an aperiodic coupling is similar to a resistance—capacity—resistance coupling, with the resistances replaced by HF chokes. The size of these chokes depends on the maximum wave-length required, and if they are basket coils about 4 in. external, and 1½ in. internal diameter wound with 600 turns of 42 SWG wire, they will work well up to 3,000 metres. The two chokes should be coupled together so that the magnetic coupling assists the capacity coupling.

No difficulties should be experienced when working one or two valve dual and crystal

circuits below 5,000 metres, but to use 3 valve dual is not so simple for the following reasons.

With three stages of HF, the HF current through the crystal becomes so great that there is a HF ripple on the voltage across the blocking condenser. This ripple being in the grid circuit of the first valve, easily causes sufficient reaction to make the whole circuit oscillate.

With three stages of LF, the LF current is so great that some of it is easily passed on to the detector by the HF coupling, and being passed through to the first grid circuit, causes the whole set to howl.

For simplicity it is therefore not advisable to use three valves as dual amplifiers, but to use the third as a simple note magnifier in the usual way.

When using these circuits with reaction for weak telephony, it is advisable to connect the crystal (cat whisker towards the grid), so that the rectified current makes the first grid positive.

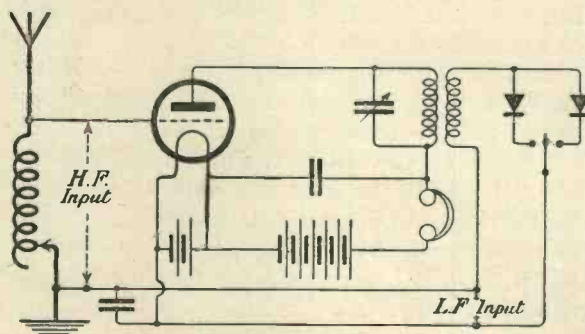

Fig. 2. A dual amplification circuit.

This introduces grid current and makes the whole circuit very stable, it being possible to eliminate overlap completely.

With loud telephony the carrier wave after detection makes the first grid so positive that it is extremely difficult to get to oscillation point, thus making it very difficult to cause interference with "Broadcasting" and other loud stations.

If the crystal connections are reversed, it makes the grid negative, and with loud stations the efficiency is greater, but it is easier to oscillate and cause interference. Fortunately, however, with the crystal reversed, the circuit instead of oscillating, often buzzes near oscillation point, and thus gives warning of what is happening.

On a 100 ft. aerial in London, 2LO owing to the limiting action of the dual valve and crystal circuit is hardly any louder than with a single valve detector circuit. PCGG, however, is just audible with the single valve detector, is audible in the loud speaker with single valve dual and crystal.

A SIMPLE WINDER FOR WAVE-WOUND COILS

By C. S. HALL.

IT is thought that the following description of a winder which will produce coils having a low self capacity will prove useful to those who construct their own apparatus. There are various types of coils on the market to-day, which are fairly expensive to buy, each having their own merits and which are similar to those about to be described, the difference being in their relative cost. Once the winder is made, coils can be made by the dozen if required, and, moreover, it can be used for a variety of other purposes.

Now, it is desired to make a coil in a compact form, the turns of which shall be separated one

finish up where it started from, and a curve will be obtained which, when developed, will appear as in Fig. 2.

Again, if the gear wheels have no common multiple, then the pencil will not finish where it started, but will be either in advance of, or behind, the starting point, and it will only be after several turns of the drum that the pencil reaches its starting point once more. In the meantime, a "band" of curves will have been traced on the drum, the appearance, when developed, being as in Fig. 3.

If we now continue winding, the same band will be traced out again, and it will be seen that

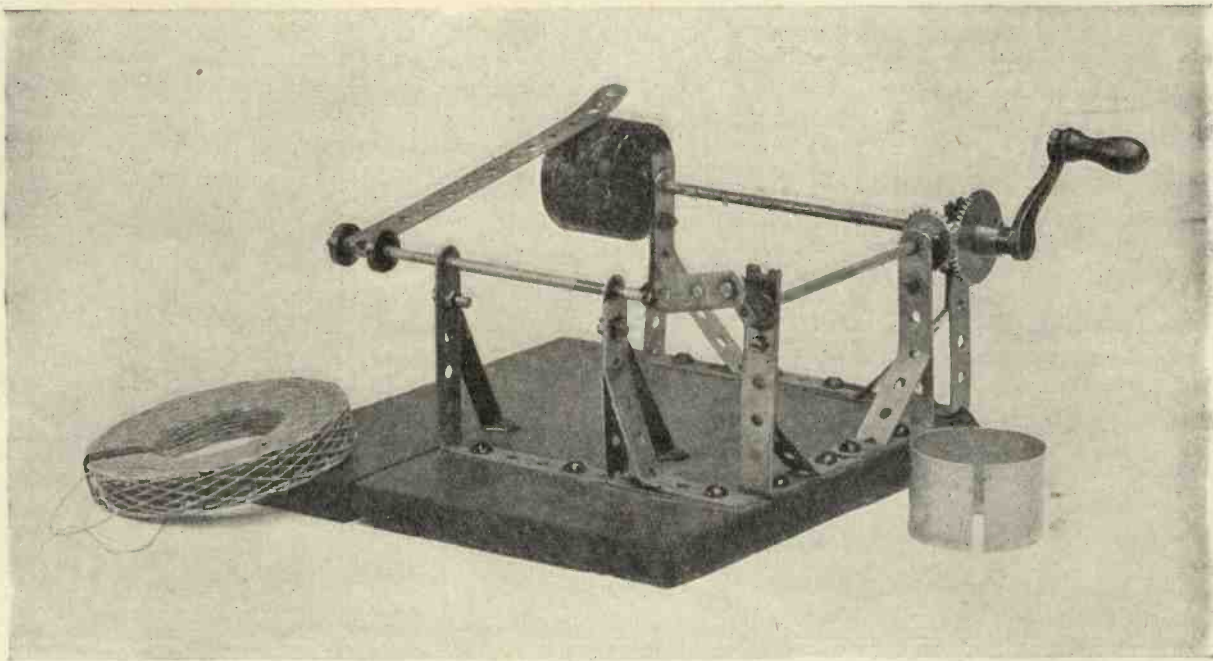

Fig. 1. General view of the coil winder, showing finished coil and split metal sleeve.

from another. Suppose we have a cylindrical drum, which may be coupled by means of a shaft (passing through the centres of its circular ends), gear wheels, and a crank and connecting rod movement, to a pencil resting on the drum (see Fig. 1), we may trace approximately a sine curve, the amplitude of which will depend on the throw of the crank. Suppose the drum makes one complete turn. If each of the gear wheels have the same number of teeth, or if the number of teeth on one is some multiple of the number on the other, then the pencil point will

considering the pencil replaced by a wire threaded through a guide, layers will be built up, and each turn will be separated from its neighbour by a definite amount depending on the number of teeth on each of the gear wheels.

In this particular case, we will take wheels having 25 and 48 teeth, the smaller being a bevel wheel from a Meccano set and the larger one bought from a dealer in gear wheels. The drum is a piece of curtain pole, $1\frac{3}{8}$ in. in diameter and $1\frac{3}{8}$ in. long. This is screwed on to a $\frac{1}{8}$ in. shaft, the other end of which carries the larger

bevel wheel and the handle by which the drum is rotated (see Fig. 4). A piece of Meccano shafting is threaded for a $\frac{1}{4}$ in. to take a piece of $\frac{1}{4}$ in. square brass rod, which is to form the crank. The other end carries the smaller bevel wheel.

Another piece of Meccano shafting is prepared to take the guide for the wire, having at one end a saw cut along its axis for about $\frac{3}{8}$ in., at right angles to which is drilled a small hole to take a split pin. A short length of Meccano strip forms the

apart, so that the coil may be slipped off the drum more easily. Usually the coil is dipped in molten wax, all superfluous wax being shaken out as far as possible afterwards, as this makes it stronger, which is of great advantage.

With a crank radius of $\frac{3}{8}$ in., a coil nearly $\frac{3}{8}$ in. wide is formed, and on the drum described it is found that eighteen turns gives a coil suitable for 180 metres with a .0005 μ F. variable condenser in shunt, 30 turns for 300 metres, and so on up to



Fig. 2.



Fig. 3.

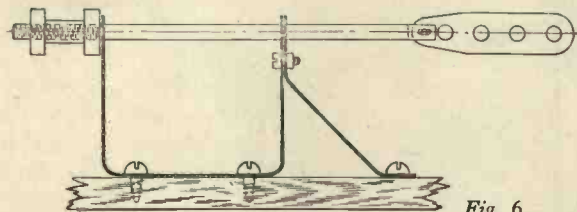

Fig. 6.

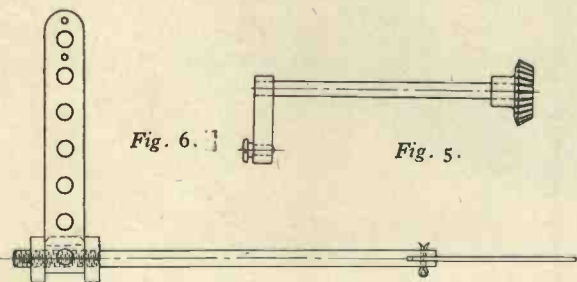

Fig. 5.

Fig. 5.

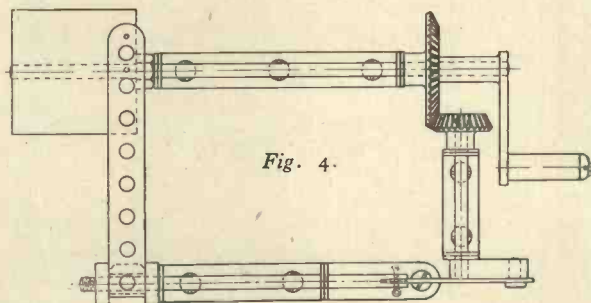

Fig. 4.

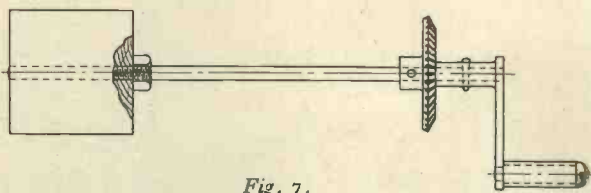

Fig. 7.

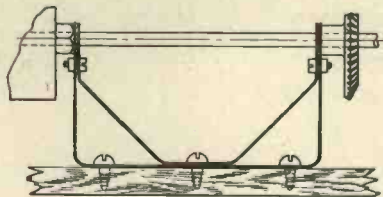

Fig. 2. Development of single turn. Fig. 3. Development of single layer. Fig. 4. Plan of assembly. Fig. 5. Details of crank and bevel Fig. 6. Details of guide and link. Fig. 7. Details of drum and bearing.

connecting rod. The other end of the guide rod carries the guide itself, the guide being bent round the rod and held in position by a nut on each side (see Fig. 6.)

All the bearings are made up from Meccano strip, and they must be very rigid. A glance at the sketches should make the construction clear.

It has been found best to wrap a thin sheet of metal round the drum, the ends being about $\frac{1}{8}$ in.

about 600 metres. The wire used is No. 28 S.W.G., D.C.C.

The winder may be used to make up H.F. interval transformers by winding on two wires at once, as the coupling between primary and secondary is a maximum, and the self capacity of each is low.

Should any difficulty be experienced in the construction or working of the machine the writer will be glad to give any assistance he can.

THE DYNATRON

By PAUL D. TYERS.

The following description of the action of the dynatron is the first of a series of articles dealing with valves of special construction and their various applications.

THE dynatron is a thermionic device operating by virtue of secondary emission. A negative resistance effect is obtained whereby the apparatus is capable of producing continuous oscillations. The dynatron may also be used as a detector, or as a current or voltage amplifier. In order to understand the mode of operation it is advisable to consider the effect of placing a conductor in close proximity to a filament which is emitting a stream of electrons. It is assumed that both are contained within a vacuous space.

Electrons striking the surface mix with those of the conductor and if the conductor is maintained at a steady potential with respect to the filament, there will be a flow of current along the external circuit. However, the total number of electrons striking the surface is not necessarily absorbed, and in many cases a large quantity is reflected. The action is governed, to a great extent, by the velocity of impact and if, under certain conditions, this is sufficiently high, a very different effect is obtained. The rapidly-moving electrons emanating

from the filament, on impinging on the surface of the conductor, knock out other electrons. It is found that the number of secondary electrons greatly exceed that of the primary electrons, which causes them to become detached from the conductor.

Advantage was taken of this fact by A. Hull, who has described an apparatus known as the dynatron. The operation of the device will be understood by referring to the accompanying diagrams. Fig. 1 shows a filament F heated by a battery B1 and an anode A which is given a high positive potential with respect to the filament by the battery B2. The anode is of spiral or perforated formation, and is in close proximity

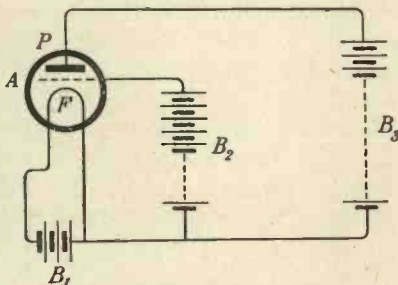

Fig. 1. The dynatron circuit.

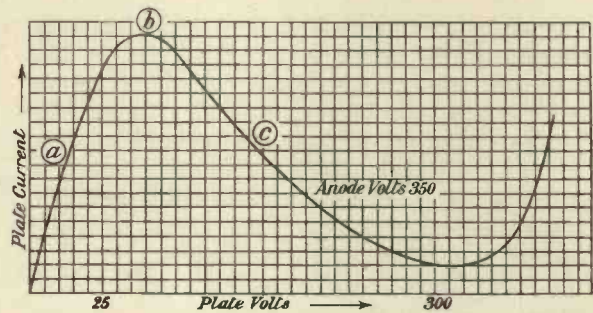

Fig. 2. A typical characteristic curve showing the relation between plate voltage and current.

to a plate P, which is given a lower positive potential by a battery B3. Electrons from F will be attracted by A, and in consequence of the very high potential will gain a high velocity. Owing to the formation of the anode many of the electrons will pass through the perforations and will bombard the plate. The speed at which the electrons strike the surface of the plate is dependent upon the potentials of the anode and plate with respect to the filament. It will be remembered that if this velocity is sufficiently high, secondary electrons will be knocked out of the molecules of the surface of the plate.

Secondary electrons will thus be formed between the plate and the anode, and, owing to the high potential of the latter, they will be

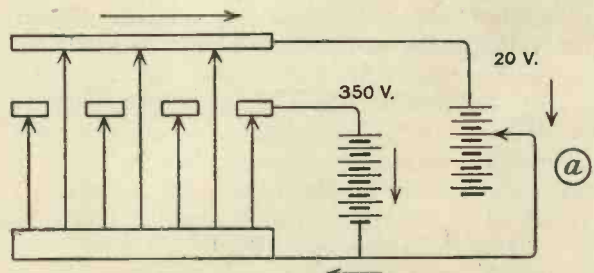

Fig. 3. Illustrating the condition corresponding to portion "a" of the curve.

attracted. Thus it will be seen that by increasing the potential of the plate, electrons are lost by it, but are replenished by the battery B3. Hence, increasing the potential of the plate with respect to the filament, causes an increase of current in the circuit, but the current is

opposite in sense to the voltage, the phenomenon being known as negative resistance.

However, there are certain critical voltages at which the effect is produced, the values depending upon the actual construction of the valve. The operation of the dynatron can be readily followed by examining a typical characteristic curve, such as that shown in Fig. 2, but it is thought that diagrams 3, 4, and 5 will make the meaning of the curve even more clear. The curve illustrated in Fig. 2 denotes the change in plate current with respect to plate voltage, the filament emission and anode potential being constant. The values of the curve are fictitious, but are of the order of those observed in practice. Plate voltages are shown along the abscissa and plate currents along the ordinate.

In following the operation of the dynatron it will be advisable to examine the curve in conjunction with Figs. 3, 4, and 5. It will be seen from the curve that as the voltage of the plate is increased the current in the plate circuit increases at a constant rate until the potential

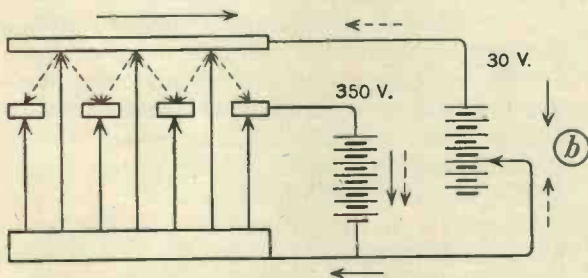

Fig. 4. Corresponding to the peak of the curve, secondary emission having begun.

reaches a value of about 25 volts. So far, the effect is practically similar to that obtained by increasing the anode voltage in an ordinary three-electrode valve, providing, of course, that the valve is not saturated. This action, represented by the first portion of the curve, is further demonstrated in Fig. 3. The filament is represented by the rectangle F and the perforated anode by A, which is maintained at a constant potential by the battery B2 of, say, 350 volts. A plate is shown at P and the potential is adjusted by the battery B3

Electrons emanating from the filament will be attracted by the anode, some passing along the anode circuit and others through the perforations, finally reaching the plate and passing along the plate circuit. The direction of the currents are indicated by the thick arrows. As the voltage of the plate is gradually raised the velocity of the electrons impinging on the surface reaches the value at which secondary emission

occurs. Owing to the high potential on the anode the secondary electrons are attracted, and it will be seen from the curve that the straight portion begins to flatten out, indicating, of course, that the current is diminishing in the plate circuit, since electrons are leaving it and are going on to the anode.

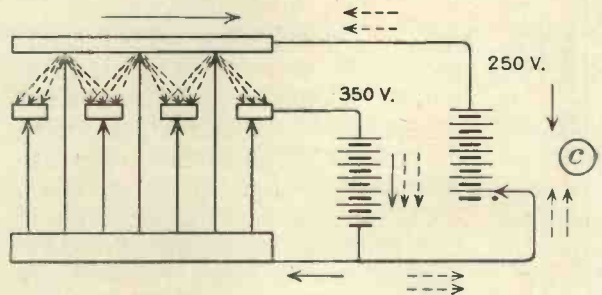

Fig. 5. Illustrating the condition of the point "c" the secondary emission being greater than the steady current in the normal direction.

This action corresponds to the part of the curve marked "b" and it is further exemplified by Fig. 4. Primary electrons are denoted by thick lines, and secondary electrons by broken lines. The total current in the plate circuit can now be considered as consisting of two components. There is a steady flow of primary electrons from the filament to the anode, the circuit being completed through the battery B3. The secondary electrons knocked out of the plate are attracted by the anode, a current then flowing round the circuit through the battery B2, the anode and the battery B3. This current, however is in the opposite direction to that originally flowing through the circuit containing the battery B3. The reason for the diminution

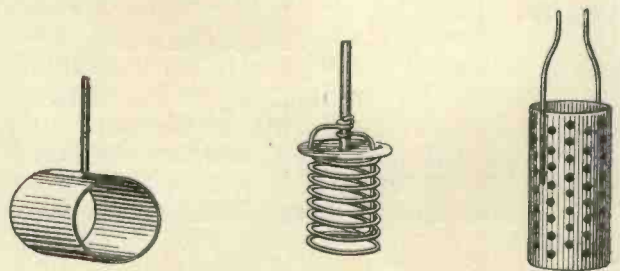

Fig. 6. Typical forms of plate and spiral or perforated anode.

of current in the circuit will now be obvious and is indicated by the downward slope of the curve. As the potential of the plate is further increased the secondary emission becomes greater, causing a greater flow of current through the anode circuit, with a corresponding reduction

in the plate circuit. This is evidenced by the continued downward slope of the curve, the action being further demonstrated by Fig. 5. As the potential of the plate approaches that of the anode the secondary electrons knocked out of the plate commence to return to it, and, consequently the current in the plate circuit increases in a normal direction as is indicated by the second bend and upward slope of the curve.

The actual construction of the dynatron somewhat resembles that of an ordinary three-electrode valve. The filament usually consists

of a spiral of fine tungsten wire. Fig. 6 gives an idea of the formation of the anode and the plate. The anode consists of either a perforated metal cylinder or a thick wire spiral. It will be seen that when the electrodes are assembled the anode is extremely close to the plate, or "target" as it is sometimes called. If the anode were not in this position secondary electrons knocked out of the plate would merely return to it in spite of the fact that the anode was at a higher potential. It is not possible to consider, in this article, the various applications of the dynatron, and it is hoped to discuss this point at some future date.

Charging Accumulators at Home

By "P. R."

The following article explains how Direct Current mains may be utilised for charging accumulators. The use of Alternating Current mains will be considered next month.

HAVING got tired of taking accumulators to be charged and paying for this work to be done, the writer decided to try and charge his own accumulators off the 230 volt D.C. lighting mains. After considerable thought it was decided to fix up a home charging plant of the kind described below, which is as inexpensive as it possibly could be. It has now been in use for twelve months and has given every satisfaction. As a photograph would not show the circuit arrangements in detail, a sketch of the outfit is given in the accompanying illustration.

It will be seen that the resistances used consist of special asbestos resistance mats which can be purchased for about 2/6 each. These resistance mats are obtainable in different values. The actual number used, and their resistance will depend upon the current which is to be passed through the accumulators for charging. The voltage of the mains is also a very important factor. The writer, as stated above, operates off D.C. mains having a pressure of 230 volts, and it is therefore necessary when charging one or more six volt accumulators to have a great deal of resistance in the circuit. The calculation of the resistance is a very simple

matter. The writer desired to charge from one to three six-volt accumulators of about 30 ampere hour capacity (continuous discharge). The charging rate for these accumulators is about 3 amperes; as the required current is 3 amperes all we have to do to find out how much resistance is necessary, is to divide 230, the voltage of the mains, by three. This gives approximately 75, and we should therefore have a resistance of 75 ohms in circuit, and this resistance must be capable of passing 3 amperes without getting too hot. The writer, therefore, bought three resistance mats, each of 20 ohms resistance, and connected them in series after having made sure that each mat was made up of resistance wire capable of passing the 3 amperes without undue heating.

It was considered desirable to be able to reduce the current through the accumulators to about 2 amperes during the later stages of charging, and an additional mat, having a resistance of 40 ohms, was included. It was only necessary for this mat to stand 2 amperes without undue heating. As the writer uses high-tension accumulators for use as anode batteries, instead of a number of dry cells, it was considered necessary to use still another resistance mat of high resis-

5/220
73

17
4
6.8

2

tance, namely, 160 ohms, so that when all the resistance mats were in series, the current passing through them, and therefore passing the high-tension accumulator, was about one ampere.

By the use of these five resistance mats it is possible to obtain any current from 1 ampere up to 5 amperes without any serious heating of any of the mats. The five mats are connected in series and supported as shown in the sketch. A shelf is affixed to the wall by angle irons. This shelf may be 8 inches wide and 5 feet long. A suitable thickness is 1 in., and to the front

first mat, while the other wire is taken to one side of the tumbler switch S, the other side of which goes to the terminal T1. To the other terminal T2 is connected a flexible insulated lead going to a spring clip C (preferably of the special type provided with a rubber cover which insulates the part squeezed) which may be attached to any point on the lower edge of any of the mats. The terminals T1 and T2 should be marked positive and negative after a test of their polarity has been made. In the figure, two six-volt accumulators A1 and A2 are shown connected

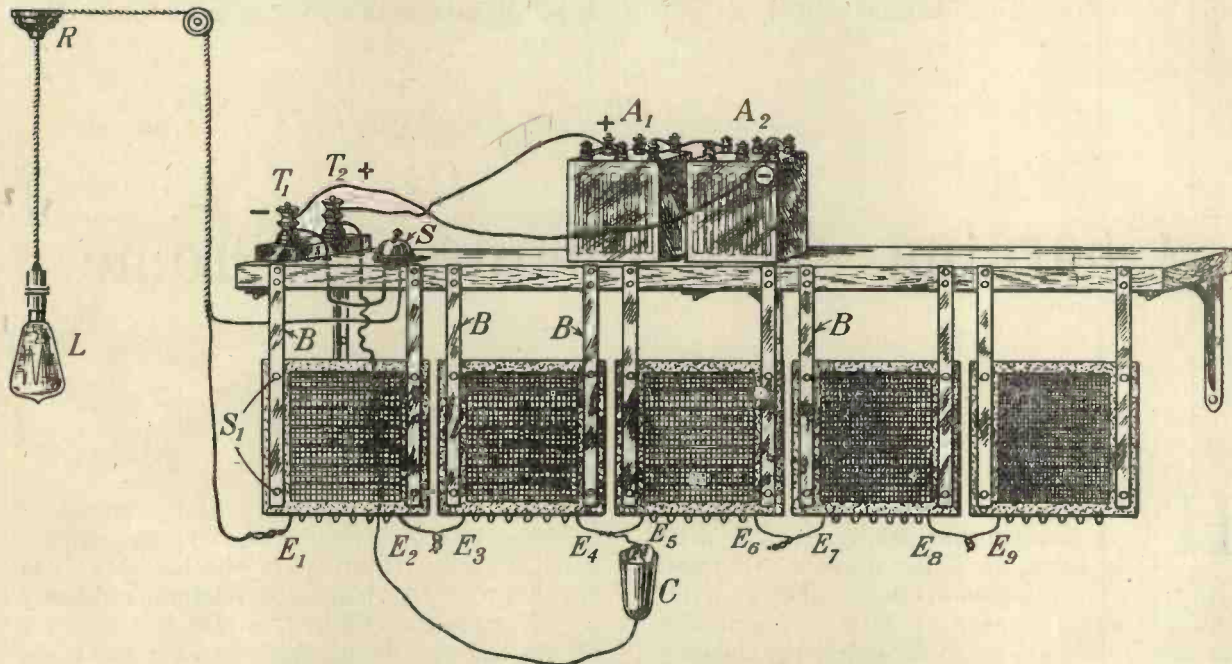

Fig. 1. Method of connecting accumulators to resistance mats. As actually shown a current of about 6 amperes will be passed through the accumulators.

edge are secured ten lengths of $\frac{1}{16}$ in. brass strip, $\frac{1}{2}$ in. wide and 9 in. long. Each strip is fixed by means of two round-headed brass screws to the front edge of the shelf.

Each resistance mat is supported by two brass strips. Each strip has two holes drilled through it, small bolts, S1, and nuts being used to secure the asbestos edge of the resistance mat to the strip. The wire end E2 of the first mat is connected to the end E3 of the second, and so on, until all the mats are in series. A pair of terminals (preferably of the double type) should be mounted on a strip of ebonite screwed to the shelf, as shown in the figure. An ordinary electric light tumbler switch S is also screwed on to the shelf.

A twin flexible lead is now taken from the nearest electric light ceiling rose R. One wire of the twin flex is taken direct to the end of E1 the

in series across T1 and T2. Charging will commence when the switch S is closed. A current of about 3 amperes is passed through the accumulators until they gas freely. The current may then be reduced to about 2 amperes or even less, by moving the clip C to the right, until each cell registers 2.6 volts.

The arrangement may be made more elaborate by including a 5 amp. fuse wire in the circuit, and also an ammeter. The house fuse wire is usually a 5 amp. one, and a special fuse is not really necessary. When charging the accumulators, the electric lamp L will usually be taken out of its socket, unless the room is being used at night. If the voltage of the lighting mains is much lower than 200 volts (e.g., 100 volts), the first mat may be omitted. Also if it is not desired to charge high-tension accumulators, the last mat may, in all cases, be omitted.

THE SINE WAVE

*By GEORGE SUTTON, A.M.I.E.E.

ONE does not attend many wireless society meetings before one encounters the lecturer, who, to make a point clear, refers to a "pure sine wave." Immediately the mathematician pricks up his ears, the average member tries to look as if he understood and approved, but the elementary member frankly gives it up, and follows the reasoning at a distance, so to speak, and hopes to catch up later on. Now it is essential for an intelligent understanding of many wireless phenomena, that we have a more or less clear view of what underlies harmonic motion, and it is the writer's effort to give an elementary idea of what this means, and how our perfect emission wave is built up upon it.

We will start with an example which is familiar to all, that of the clock pendulum. It requires little consideration to appreciate that when the pendulum is travelling over the space immediately below its point of suspension it is moving at its greatest velocity. This velocity diminishes and dies down to nothing, when the pendulum has reached the end of its excursion,

when, immediately after stopping, it reverses its direction of swing. No clock could keep time if the succeeding pendulum swings did not each occupy the same length of time, and normally the length of swing does not vary very much, therefore it follows that when it passes its centre point it is always moving at the same velocity.

Let us set off, on a straight line a number of

points, say 26, the distance between each of which shall be the distance travelled over by the pendulum in one twenty-sixth of its swing. At the middle of the line the distance between the points would be greatest, because the pendulum would be there swinging at its greatest speed while near the ends of the lines, the points would get closer and closer together. From these points set up perpendicular lines which will meet the circumference of a circle to be

drawn from the middle of the line, with half the line as radius, and the intersection of these perpendiculars will divide the circumference into equal arcs.

This circle, which is shown in Fig. 1., is called the circle of reference of the motion of the pendulum, and nearly all regularly recurrent cycles of operations, like the swing of the pendulum, can be analysed by building up such a circle and studying it.

First of all, the ratio of the circumference to the diameter, about 3.1416, or $3\frac{1}{7}$ plays a part in the solution of these problems. But in

what manner is all this going to help us? First of all, we built up the circle of reference, and now we make use of this circle to study the sine wave form. Imagine a point circulating at a uniform known speed. Its position at any moment may be determined by this method. In one case by calculating what point it has reached on the circle, and in the other, chiefly used mathematically, by calculating where its trace or shadow would be on the horizontal line.

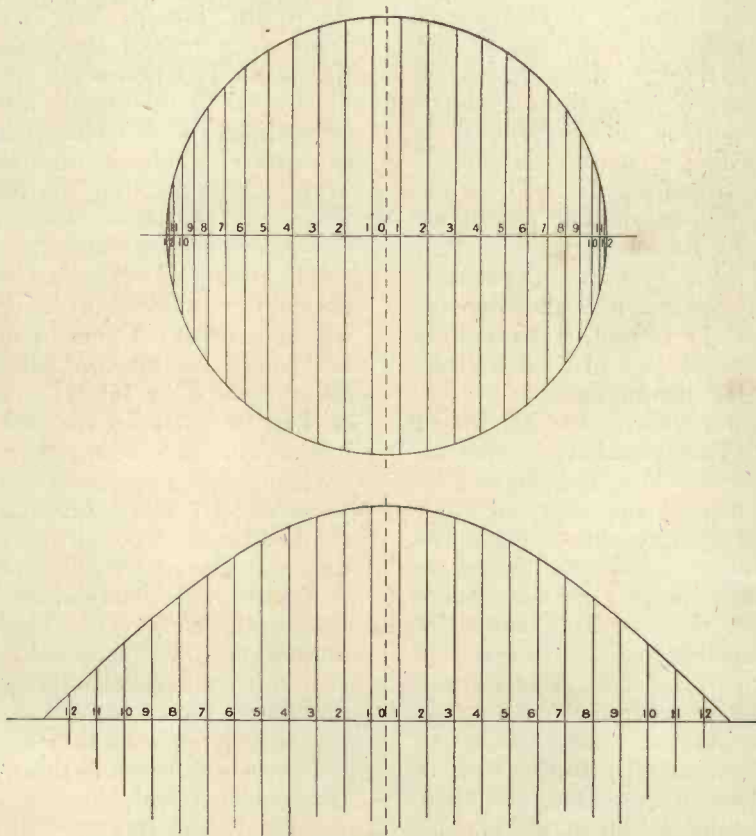

Fig. 1 The formation of a Sine Wave.

Thus, with regard to the clock, the pendulum would have a movement to the right, followed by a movement to the left. With regard to a ribbon of paper moving uniformly under the clock from left to right, the trace or shadow might appear to move twice as fast at one time as it actually did, followed by a dead standstill, or even an apparent reversal. If the ribbon of paper were moved in a line at right angles to the path of the motion of the pendulum, the trace of the pendulum bob would be a sine wave curve, and it is this curve which is most studied when we are considering oscillations of current set up in a wireless circuit.

Let us get back again to our first example. The equidistant points on the circumference of the circle when projected down on to the horizontal diameter, though they represent, when on the circumference, equal intervals of time, as the moving particle taking that path is supposed to be travelling at a uniform rate of speed, yet they are crowded together at the ends of the line as the motion of the pendulum which we were plotting was slower there. But, take the projection of the longest distance between two points on the horizontal line and step off this distance on a new horizontal, and now this new line represents the passage of time and not the path of a swinging pendulum.

From the first figure, transfer the heights of the perpendiculars to those similarly numbered, but equidistant on the new line, and the ends of these lines will now make points in a sine wave curve, and the rate of change of the slope of the curve will at any point represent the change of velocity of the moving particle whose motion we are studying. It is obvious that this kind of analysis could not be studied at the rate of reversal of the alternating electric light current of 50 cycles per second, still less with a 300 metre wireless wave of 1,000,000 cycles per second, but there are means of getting a trace of what really takes place in that time, and then, like the slowing down of a film at the cinema, put the thing through very slowly and study it at our leisure. The sine wave we have built up is a "pure sine wave," that is, it portrays only the fundamental vibration of whatever kind of harmonic motion we are studying.

It is possible, however, with many recurring harmonic oscillations to have a more complex form of cyclic motion. Suppose, for example, our pendulum in swinging had also a "wobble," such as is often the case with clock pendulums, it would be necessary, if making a detailed study, to take into account this wobble, and the curve

would have to show the periodic tremor which this parasitic disturbance caused. Indeed, this is just the office of harmonic analysis, as this study is called, to find out first of all if a tremor is taking place, in the second place to trace its cause, and then, if desired, to arrange for its prevention or removal.

When, however, we come to study a musical instrument, emitting a note, we find that the characteristic tone or timbre depends on the purity or complexity of its sound wave formation. For example, the flute note is very pure, while the violin note is very complex. Purity in this case does not necessarily mean pleasantness, for one is sooner tired of the note of the flute than of the violin, for the very reason that they are relatively pure and complex. Analogous with this is the fact that a pure primary colour does not appeal to the artistic taste as does a mixed or modified tint. With wireless, we want a pure sine wave when we are sending Continuous Wave telegraphy, but the harmonics emanating from our big stations indicate that their emission is by no means so pure as to be perfect.

The timing of a blow is closely associated with harmonic motion. Any cricket or tennis player will know what is meant by perfect timing. It is not enough to hit the ball. To get the best effect it must be hit at a certain instant. In cricket, for example, the ball must be hit when it is at such a spot in the air that the forward swinging bat shall present its face at such a perpendicular and horizontal angle as to place the ball on its rebound just where the batsman desires it should go.

A little reflection will show that this timing has to be done very closely. In harmonic motion this manipulation has not to be done once now and again, but every time the phase of motion recurs at, we will say, the one millionth part of a second, and the importance of the study will now perhaps be manifest, particularly in the incidence and effect of the harmonics with relation to the fundamental. In our diagram of a sine wave curve it may be that it is spread out laterally much more than usual, but one has only to set the ordinates or equidistantly placed vertical lines closer together to obtain the dimensions of the curve as usually drawn. It should be noticed that if the time by this means is made to appear to pass more rapidly the slope of the curve is also changing in exactly the same proportion, and this is a property of the sine curve, which, expressed mathematically, is the ratio of the perpendicular to the hypotenuse.

A Great New Wireless Invention

The exclusive article given below is the first published account of an extremely important invention in connection with the reception of wireless signals. The invention is in use in the stations of the Imperial Wireless Chain and other British Government stations.

THE problems of lessening the effect of atmospheric and interfering signals is as old as wireless, and once the problem is solved the power used for transmitting purposes may be greatly cut down. Many attempts have been made to provide efficient apparatus for the decrease of the defect of atmospherics, but the success attained has been very small. At last, however, after years of experimental work

Northolt stations, and at the British Post Office in London, at the Cairo station of the Imperial Wireless Chain, and at other important stations owned by the Government.

We have had the privilege of witnessing demonstrations of the apparatus and we have also carried out tests ourselves, which have been extraordinarily successful in the elimination of atmospherics.

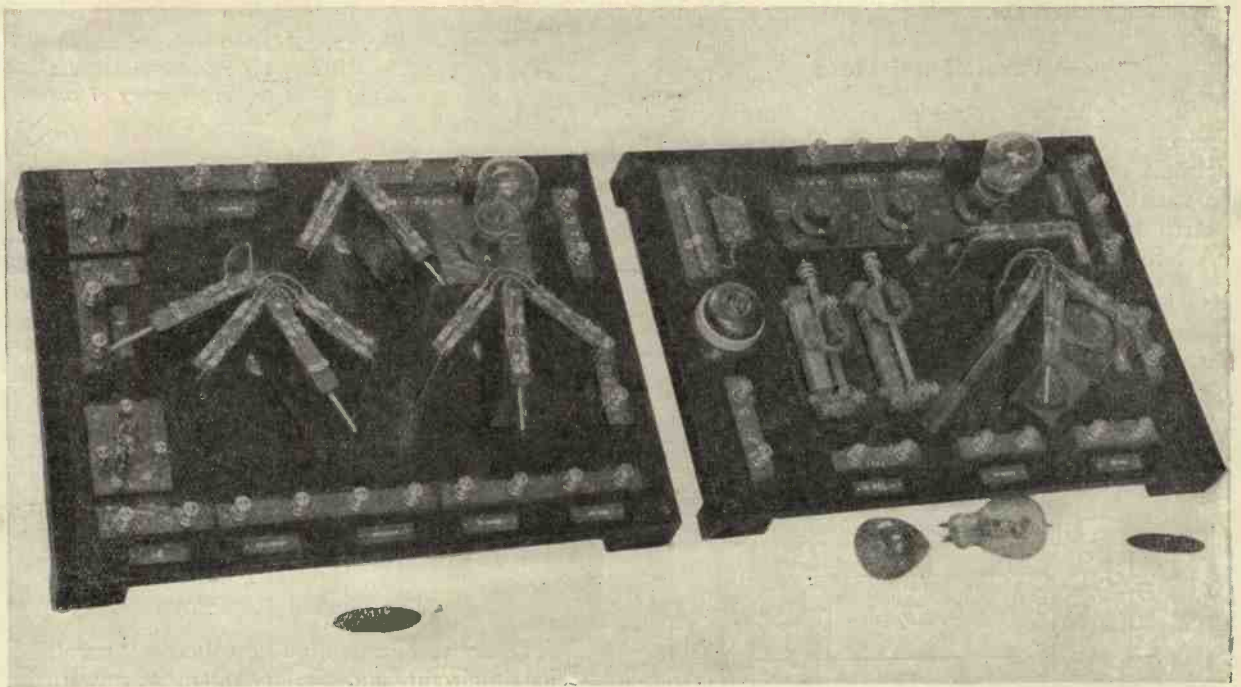

[By courtesy of Anode Wireless & Scientific Instruments Ltd.]

A Hinton receiver made to the Post Office Engineering Department's detailed specifications and design.

a British wireless engineer, Mr. N. P. Hinton, B.Sc., of the British Post Office, has evolved a circuitual arrangement which has met with the greatest success. The committee appointed to design the stations of the Imperial Wireless Chain, has, after examining all other systems, decided to employ the Hinton receiver on the stations of the Imperial Wireless Chain. The apparatus is already installed at the Leafield and

By the use of the Hinton invention it is not possible to cut out atmospherics altogether, but their strength is so greatly reduced as to render their disturbing effect negligible. Probably no worse place for a receiving station could be found than Cairo, situated, as it is, near to the Sahara Desert; yet even here, long distance communication of a thoroughly reliable character has been made possible by the use of this

remarkable development in wireless reception. The new invention is of a comparatively simple nature, and it is applicable to different kinds of signals and to waves of all length. The benefits obtained are most valuable in the case of long distance reception of continuous waves.

Rejector Circuits

For conducting communications over distances of 2,000 miles and upwards, the circuits are particularly successful. On the other hand, the arrangements have been operated with marked success on wave-lengths down to 300 metres. On the shorter wave-lengths, however, trouble is not usually experienced with atmospherics, the chief advantage gained being the ability to tune out signals from undesired stations. The invention operates by virtue of rejector circuits operating on high or low-frequency currents.

Parallel Rejectors

Fig. 1 shows a receiving circuit employing a rejector oscillation circuit. An ordinary aerial circuit comprising a variable condenser C_1 and a variable inductance L_1 is arranged, but in the earth lead two additional circuits are inserted. A left-hand one, $L_3 C_3$, is a closed oscillation circuit, tuned to the frequency of the incoming signals. Another tuned circuit, $L_2 C_2$, is arranged in parallel with $L_3 C_3$, as shown in the diagram. To the inductance L_2 is coupled an inductance L_4 , shunted by a tuning condenser C_4 . A de-

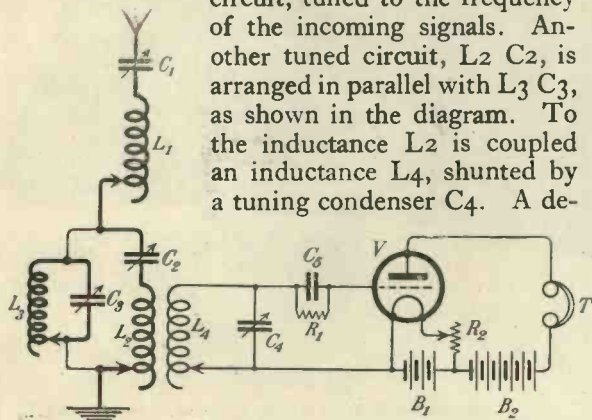

Fig. 1. A simple parallel rejector circuit.

tector, which in the diagram is shown as a valve V , is connected across the circuit $L_4 C_4$, which is tuned to the desired signals.

The operation of this simple circuit is briefly as follows. Incoming signals influence the aerial system and produce currents of a given frequency. These currents, due to the desired signals, cannot pass through the circuit $L_3 C_3$, as this circuit is tuned to their frequency, and therefore offers a very high impedance to them.

The oscillations, however, can pass through L_2 and so to earth. The desired oscillations flowing through L_2 , induce similar oscillations in the circuit $L_4 C_4$, and these are then detected, the signals being heard in the telephones T .

At the same time that the desired oscillations are flowing in the aerial circuit, there are probably currents of different frequencies also flowing in that circuit, these currents being due to interfering waves. These oscillations will readily

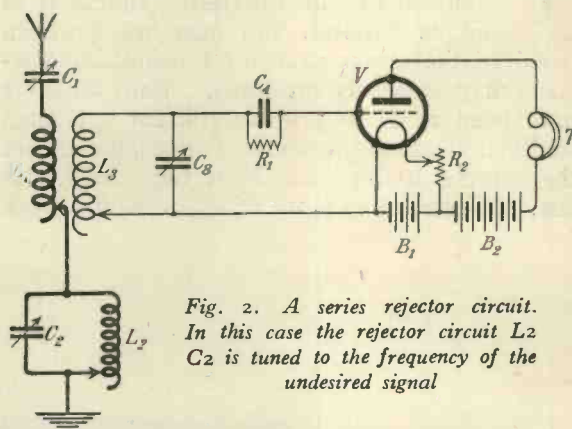

Fig. 2. A series rejector circuit. In this case the rejector circuit $L_2 C_2$ is tuned to the frequency of the undesired signal

pass through the circuit $L_3 C_3$, as this circuit is not tuned to their frequency. The circuit $L_3 C_3$ now acts as a short circuit for the interfering currents, but has a very high impedance to the desired signals passing round the right-hand circuit which may be called the "acceptor" circuit. The circuit $L_3 C_3$ is called the "rejector" circuit, as it rejects the desired signals. We see then that the undesired currents flow direct to earth through the circuit $L_3 C_3$ while the desired currents flow through $C_2 L_2$. By means of a circuit of this kind it is possible to cut down interference to a very large extent.

The Series Rejectors

The above circuit may be called a "parallel" rejector circuit, and the arrangement now to be described is called a "series" rejector circuit. This consists of an oscillation circuit tuned to the frequency of an interfering signal, this circuit being included in the aerial circuit of the receiver. Fig. 2 shows a suitable arrangement. It will be seen that in the earth lead is an oscillation circuit $L_2 C_2$, which is tuned to the frequency of a particular signal which is causing interference. To the inductance L_1 is coupled the circuit $L_3 C_3$ which is tuned to the desired signal, the valve V acting as a detector, as in the case of Fig. 1. When the circuit $L_2 C_2$ is tuned to the same frequency as that of the interfering

signals the circuit will offer a very high impedance to those particular signals and so will prevent them passing through the aerial circuit. As the circuit $L_2 C_2$ is tuned to a frequency different from that of the desired signals the latter will pass to earth through the circuit $L_2 C_2$ without difficulty. Additional rejector circuits may be connected in series with the aerial to keep out different interfering signals.

Use of Reaction

The simple rejector arrangements of Fig. 1 and 2 do not give the best results obtainable because it is not possible to make the rejector circuit present an infinite impedance. In Fig. 1 the circuit $L_3 C_3$ will only act as a circuit of infinite impedance to the desired signals if its resistance is zero.

By applying reaction to the rejector circuit it is possible to reduce its resistance to practically zero. Fig. 3 shows a parallel rejector circuit in which a valve V is used to lessen the damping of the circuit $L_3 C_3$. This circuit is connected across the grid and filament of the valve V , a coil L_5 being connected in the plate circuit of the valve and coupled in a variable manner to the inductance L_3 . The inductance L_2 in the acceptor branch of the

L_5 and L_3 is now tightened until the valve V is on the point of oscillation, i.e., when the maximum reaction is obtained without self-oscilla-

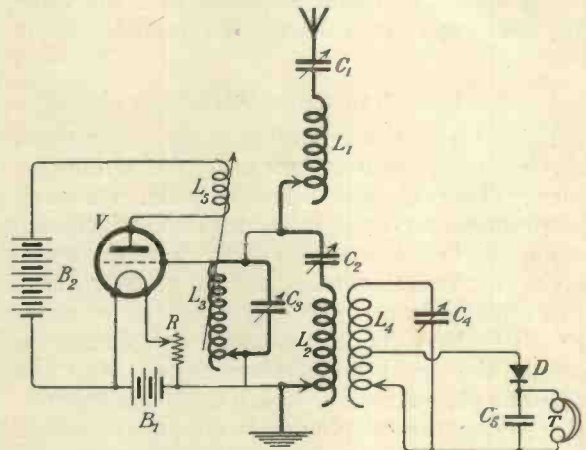

Fig. 3. A parallel rejector circuit using reaction.

tion. The impedance of the circuit $L_3 C_3$ to the desired signals is now practically infinite, and the whole circuit will be found extremely selective.

A Complete Receiving System

Fig. 4 shows a complete receiving system in

which a rejector circuit is included in the closed receiving circuit. In the figure, an ordinary tuned aerial circuit is employed, a closed receiving circuit $L_2 C_2$ tuned to the wave-length of the desired signals being connected across filament and grid of a valve V_1 . Across the grid and filament of this valve

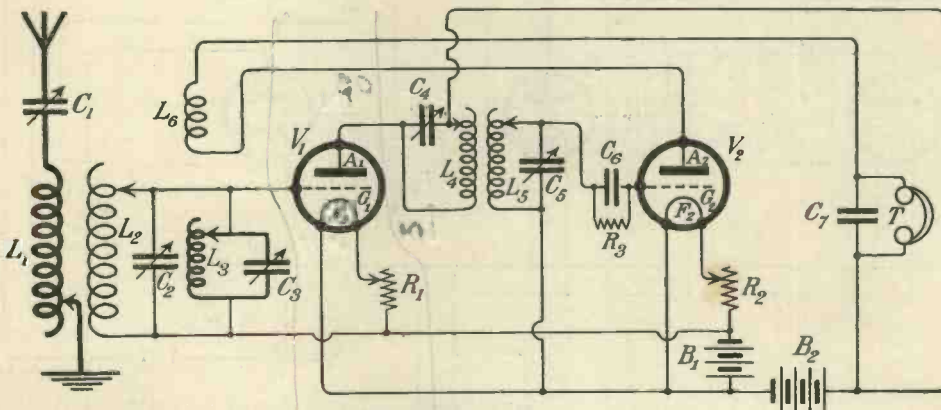

Fig. 4. A receiver employing a parallel rejector circuit with reaction.

circuit is coupled to a closed receiving circuit $L_4 C_4$, tuned to the desired signals. A crystal detector D and telephones T are connected across the condenser C_4 , or preferably across a portion of the inductance L_4 . Instead of using the crystal detector D , a valve receiver, of course, may be employed.

The apparatus is not difficult to adjust. The circuit $L_3 C_3$ is carefully tuned to the desired wave-length and $C_1 L_1, C_2 L_2$ are carefully adjusted until the maximum signals are obtained in the telephones T . The coupling between

is also connected a rejector circuit $L_3 C_3$ which acts as a short circuit for undesired signals and currents, but as a circuit of almost infinite impedance to the desired currents. The coupling between the valve V_1 and a second valve V_2 is effected by an oscillation transformer having its primary and secondary tuned to the desired wave-length. The coupling between the inductances L_4 and L_5 is very loose. In the plate circuit of the valve V_2 is an inductance coil L_6 which is coupled to L_3 in a way as to produce a reaction effect on the circuit

$L_3 C_3$, thereby reducing its resistance. In the plate circuit are also included the telephones T. A circuit of this kind greatly reduces interference, and if a local oscillator is placed near the valve V_2 , continuous waves may be received by this system.

Low-Frequency Rejectors

The invention is applicable to the reception of low-frequency signals, such as the audio-frequency beat signals obtained when receiving continuous waves. It could also, of course, be applied to the reception of any kind of signals having a musical note. In Fig. 5 an ordinary interval transformer or input transformer $T_1 T_2$ has its secondary T_2 connected across the grid and filament of a valve V , in the plate circuit of which are the telephones T . Across the telephones is connected a low-frequency circuit $T_3 C$ tuned to the particular note it is desired to receive. The circuit $T_3 C$ is, therefore, a low-frequency circuit having a natural frequency of, say, 1,000. The inductance coil T_3 is coupled to the coil T_2 with the result that a reaction effect is obtained in the circuit

different frequency, however, such as atmospherics, which are generally of low frequency, will pass straight through the circuit $T_3 C$ which will therefore act as a short circuit for

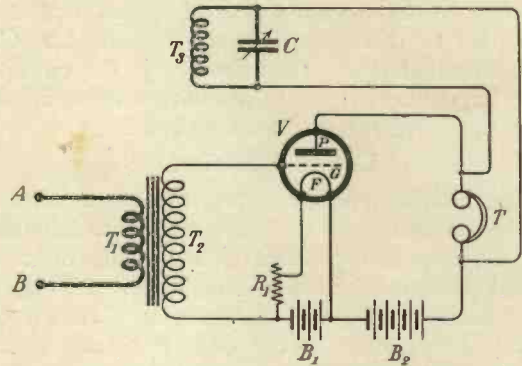

Fig. 5. A low frequency rejector circuit.

these sorts of currents and practically prevent them going through the telephones T. The coupling between T_3 and T_2 is, of course, critical, and must not be so tight as to produce a ringing effect which is liable to continue after the signal.

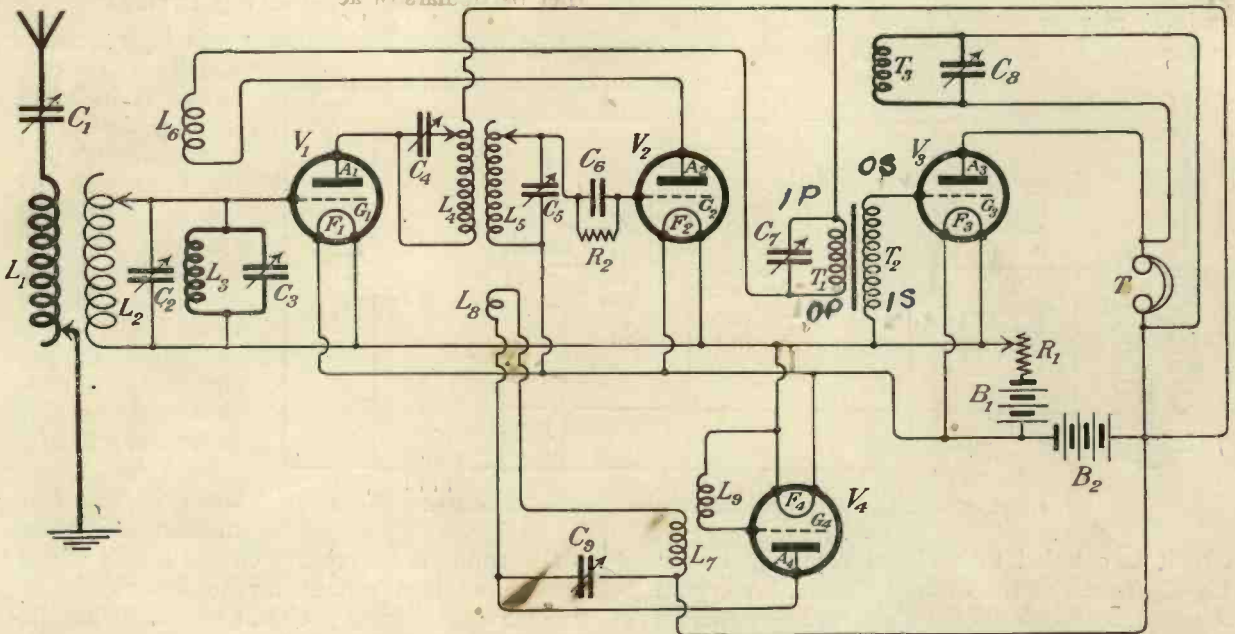

Fig. 6. A complete receiver using radio and audio frequency rejector circuits.

$T_3 C$, reducing its resistance to a negligible quantity. Under these circumstances the circuit $T_3 C$ will not allow the audio-frequency currents of desired frequency to pass through it; the currents will therefore pass through the telephones T and operate them. Currents of

A Complete Installation Employing High and Low Frequency Rejectors

Fig. 6 shows a complete receiving installation operating with rejectors both in the high-frequency circuits and also in the low-frequency circuits. The arrangement for the most part is

similar to that shown in Fig. 4. A low frequency amplifying valve V_3 is, however, added and note frequency selectivity is obtained by the method just described. A local oscillator valve V_4 is provided for producing continuous oscillations of a frequency slightly different from the frequency of the incoming signals. The audio-frequency beats are rectified by the valve V_2 and

effective. Very loose coupling between the intervalve oscillation transformer is necessary and means for very carefully adjusting the reaction between L_6 L_3 must be provided. A mechanical movement of the coil L_6 is hardly of sufficient accuracy for general purposes. A variable condenser C_7 is therefore included across the primary T_1 of the iron-core transformer T_1 T_2 . This condenser is not for the purpose of tuning the transformer at all, but is merely for the purpose of varying the impedance of the anode circuit, and therefore the strength of the currents in the coil L_6 .

A Series Rejector Using Reaction

Fig. 7 shows a rejector circuit in which reaction is applied to a series rejector tuned to the frequency of an undesired signal. The rejector circuit is connected across grid and filament of the valve V which has a coil L_3 in its anode circuit.

The above particulars of the invention are sufficient to enable it to be constructed and operated, but in a future issue we hope to give further particulars of actual sets in use, together with photographs and further remarks regarding the use of these circuits for lessening interference, and for reducing atmospherics. The invention which has been described marks a new stage in the progress of wireless reception. It is not merely a theoretical suggestion, but is an arrangement which has given excellent results for months on stations of the Imperial Wireless Chain, and there can be no doubt of its great commercial value in the future.

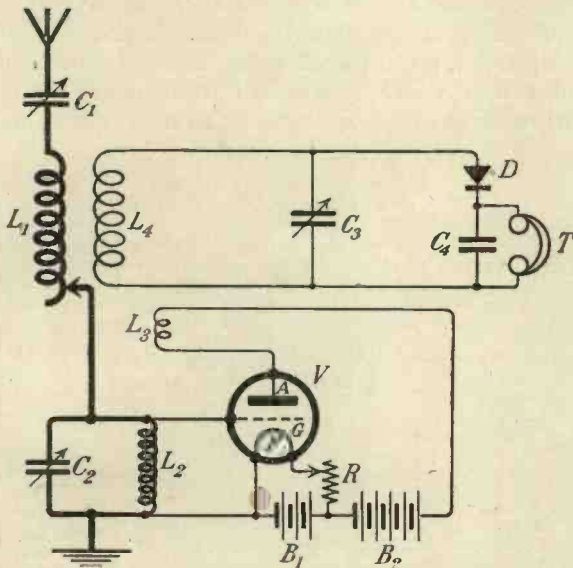

Fig. 7. A series rejector circuit employing reaction.

amplified by the valve V_3 , the circuit T_3 C_8 , of course being tuned to the beat frequency.

A circuit of this kind in which the rejector circuits on the high-frequency and also on the low-frequency side are employed is extremely

A CONDUCTING CEMENT

Difficulty is sometimes experienced in obtaining a good electrical contact between a metallic body and a partial conductor, or some substance which cannot be soldered. For example, it is not always easy to obtain a connection to some types of grid leaks or anode resistances. A very good composition may be made from a powdered conductor, such as graphite, together with some binding material such as gum arabic. The graphite should be as finely divided as possible, and it may best be obtained by gently scraping a block of "black lead" such as is used for polishing stoves. A small heap should be scraped on to a piece of wood, upon which the paste is made.

Gum arabic is usually sold in small lumps, and this should be dissolved in water, until a very thick liquid is obtained. The process is somewhat slow, and it is advisable to dissolve the gum some time before it is to be used. The graphite is worked into a very stiff paste, with a small piece of wood, or an old knife blade, adding the gum drop by drop. The cement will remain in a workable state for several hours, but as soon as it begins to crumble and break, it gives a rather indifferent contact. It is advisable, therefore, not to make more than is required for immediate use.

P.D.T.

The Sinking of S.S. "Hammonia"

A personal narrative by A. E. Hunter, the chief operator of the "Kinfauns Castle," which saved 500 lives by responding to the S.O.S. of the sinking liner.

DURING our careers in life there is no doubt some incident that impresses us more than others, and in many cases we look back upon it with horror and dread. I shall not forget the morning of September 9th, 1922, when, on taking up my duties in the wireless cabin of the *R. M. S. Kinfauns Castle* I received the distress signal from the Hamburg American

that the stricken vessel was not very far away. Little time was wasted in giving this information to the Captain, and before long we were full speed ahead to the scene of the disaster. It is not necessary to describe here the horrors of shipwreck, the capsized boats, and the drowning of people which it was our unfortunate lot to witness, but to deal more with the wireless side

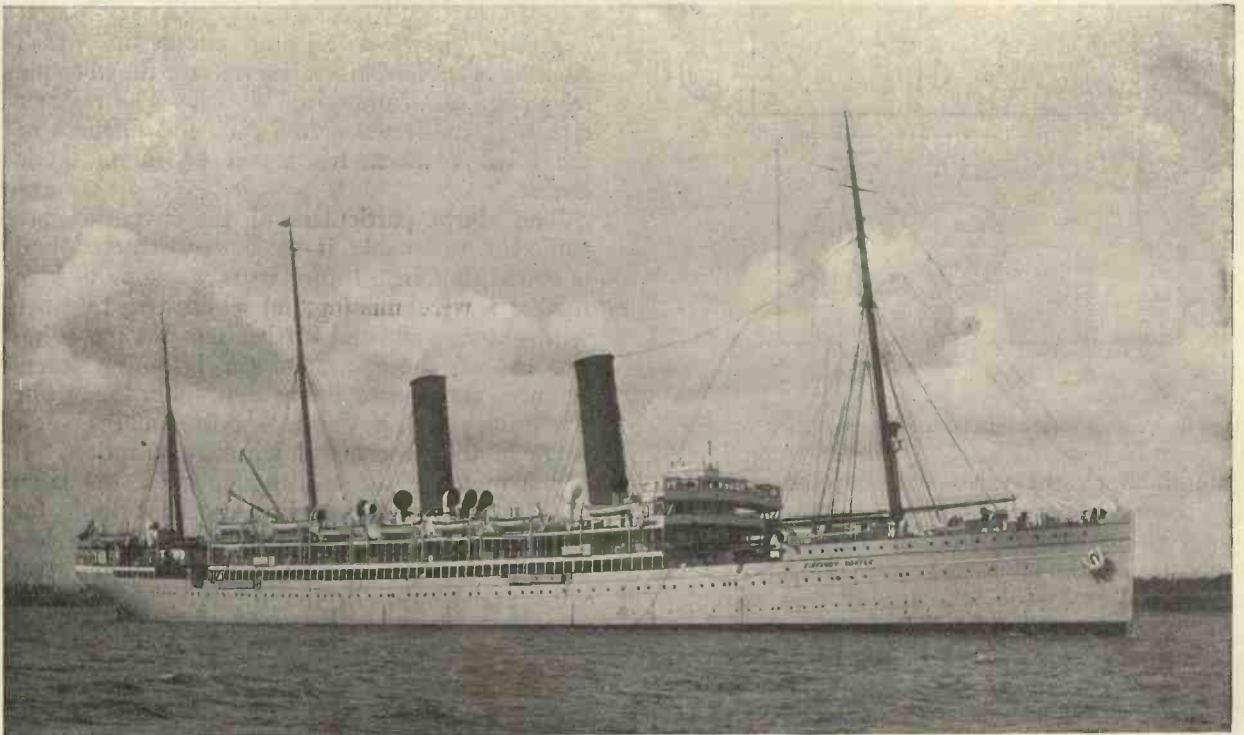

The "Kinfauns Castle," which responded in the S.O.S. of the "Hammonia."

Liner *Hammonia*. The message received was indeed a startling one. The usual "S.O.S." was being broadcasted, followed by "Not expected to remain afloat for more than one hour and over eight-hundred souls aboard." Eight hundred souls! After a quite uneventful voyage in the sunshine of the last two weeks, such a call over the ether seemed impossible, and on reception of such a message one is staggered for a few minutes, and liable to doubt its accuracy. There could be no doubt about this however. The *Hammonia's* wireless signals were loud and clear, and therefore it was pretty plain

of the disaster. It is sufficient to mention that once again wireless telegraphy has proved itself to be an absolute necessity for safety at sea, and it must be admitted that it was solely through its prompt action that nearly five hundred souls were picked up by the *Kinfauns Castle*, and the rest of the survivors by other vessels who had also answered the *Hammonia's* call. For eight hours effective communication was kept up with the distressed vessel, until she sank at 6.30 p.m. Everything from the wireless point of view worked splendidly. As we drew nearer the scene the position became more grave. The

appeals for help became more urgent, stating that the vessel could not remain afloat longer than half-an-hour, and that immediate assistance was necessary. On arrival at the scene of the disaster, which was about noon, the *Hammonia* presented a sorry spectacle, listing to starboard at an ugly



The operators of the two vessels—left to right, R. Roy, 2nd Operator of the "*Kinfauns Castle*"; 2nd Operator of the "*Hammonia*"; A. E. Hunter, Chief Operator of the "*Kinfauns Castle*"; Heinrich Stoldt, Chief Operator of the "*Hammonia*."

angle. Quickly the boats were lowered and after wonderful instances of pluck and endurance on the part of the officers and crew of the *Kinfauns Castle*, they succeeded in bringing the remainder of the survivors aboard safely. The last boatload left the *Hammonia* at about 6.25, and none too soon, for at 6.30 p.m. the vessel sank.

Here again, then, is another triumph for wireless, yet in the face of all these glaring facts, articles have appeared in leading papers recently to the effect that wireless was not so important in saving life as it is made out to be. I should like to point out, however, I saw the disaster, and was in communication with the ship until she sank, that without wireless the result would have been appalling. In all probability not a soul would have been saved. Those who had been fortunate enough to get away in the boats would have had to face all the horrors of being cast adrift, and with very little hope of ever being picked up, while the rest would have gone down with the vessel. With regard to wireless as a means of saving life, I wonder what the survivors of the *Hammonia* think about it? I understand that

when the *Kinfauns Castle* appeared on the horizon they set up a tremendous cheering, and many of the men amongst them broke into song, endeavouring to keep up the spirits of those who had apparently given up all hope. Without wireless, then, there would have been no *Kinfauns Castle* to the rescue of these unfortunate people, nor would *S.S. Soldier Prince*, *City of Valentia*, *City of Chester*, *Euclid*, etc., have gone to their assistance. They would have all passed by and continued on their respective courses, ignorant of the disaster near by. As it is in this case, so it was in other disasters, where wireless played such an important part, the *Titanic*, *Republic*, *Volturno*, and a whole host of other vessels, particularly during the War. Wireless has saved thousands of lives, and it will save thousands more.

As the survivors came aboard they naturally made for the wireless cabin to seek information concerning their friends, relations, children, etc., who were missing, or had been picked up by other ships.

This was a pitiful affair, and entailed a lot of work, keeping us busy until our arrival at Southampton. Time and space will not let me give a fuller description here, however,

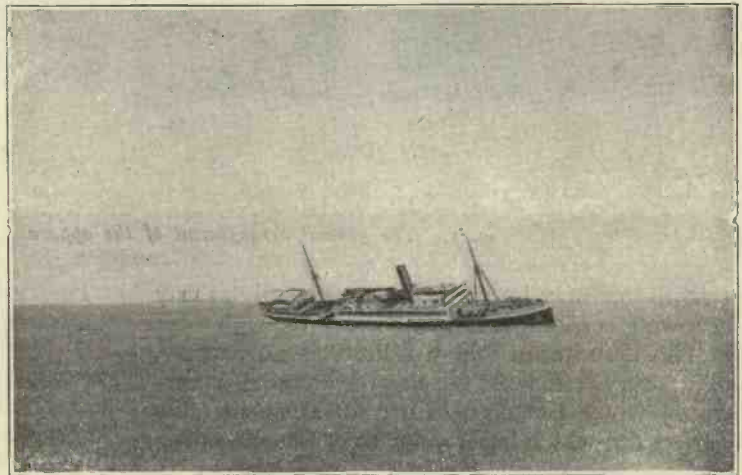

The "*Hammonia*" listing to starboard.

[By courtesy of "*The Signal*."

but in conclusion it might be mentioned that in the case of the survivors of the *S.S. Hammonia*, wireless telegraphy saved their lives, in many cases gave them particulars of their missing loved ones, and told their friends and relations in all parts of the world that they had been saved.

A SIMPLE WIRELESS TELEPHONE TRANSMITTER

The following is a description of a very simple wireless telephone transmitter, having a range of about twenty miles. In next month's issue there will be another article on wireless telephone transmission.

THERE are only some 500 radio experimenters in this country who enjoy the privilege of possessing a transmitting licence. This almost seems to indicate that many receiving enthusiasts are under the impression that a wireless telephone transmitter is a complicated arrangement, which needs special valves, a special generator and a number of other accessories, expensive to buy or difficult to make. This, however, is very far from being the case. A very effective wireless telephone

variable air-condenser. The high-tension supply may be of any suitable kind which gives about 200 volts. The arrangement described here is regularly worked off D.C. mains, giving just over 200 volts.

The principle on which the wireless telephone works is as follows. The simple valve oscillator circuit is arranged, the aerial and earth being connected to the oscillation circuit. To this circuit is coupled an inductance coil across which is connected a microphone of the Standard

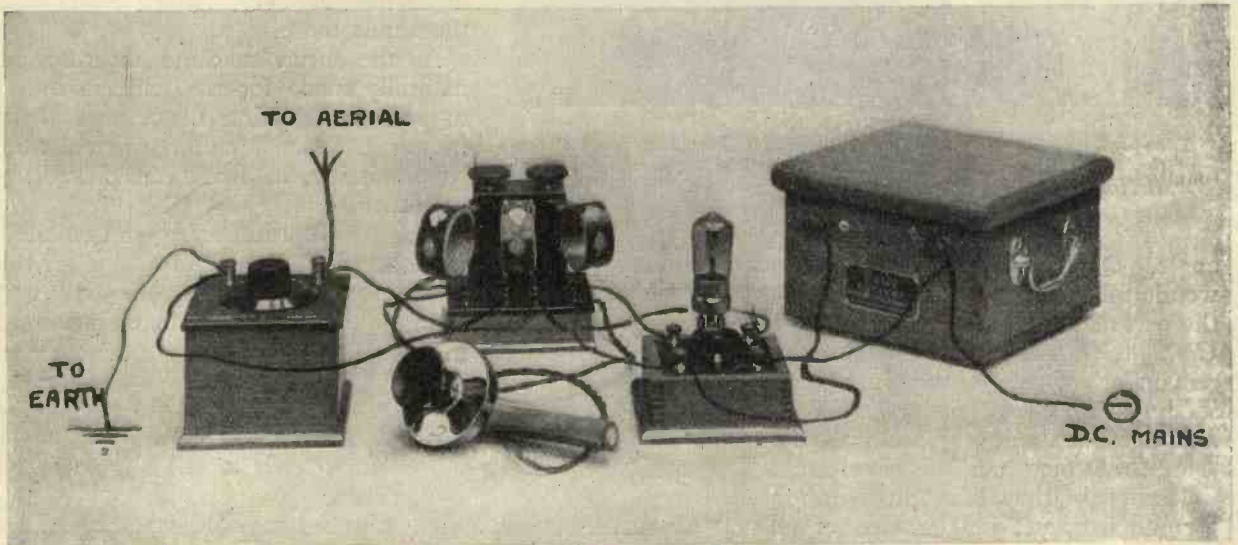

Fig. 1. The general arrangement of the apparatus, showing connections.

transmitter may be made just as cheaply as any receiving set, and it is just as easy to work.

The description which follows is an account of a very efficient wireless telephone transmitter which has been in use for a considerable period and which has a range of at least 20 miles. Signals have been given perfectly clearly 15 miles across London with a single valve receiver. The modulation obtained is excellent and for low power work the arrangement could hardly be better. Fig. 1 is a photograph of the complete set. It will be seen that it is composed of a triple coil holder with three honeycomb or similar coils, a microphone transmitter, a valve panel with valve holder and rheostat and a

Post Office type. When speaking into the microphone a variable amount of high frequency current is withdrawn from the aerial circuit with a consequent variation in the radiation.

Particulars of the Circuit.

The actual circuit used is shown in Fig. 2. Three honeycomb coils or similar interchangeable coils, L_1 , L_2 , and L_3 are mounted in the manner shown, the middle coil being fixed and the two outer coils being movable, so that the coupling to L_1 may be varied. The size of the coils will vary according to the wave-length to be radiated. It will usually be found that L_3 is the smallest coil, L_1 is the next largest and L_2

the largest of all. The actual coils used for 440 metres transmission were as follows: L_1 was a number 35 Igranic honeycomb coil, L_2 was a number 75 coil, and L_3 was a number 35, although number 25 also gave good results. Across the coil L_1 was connected the variable condenser C_1 , a convenient value for which is 0.0005 mfd. One side of this condenser is connected to the aerial, and the other side is connected to earth. The top side of the condenser C_1 is also connected to the plate P of the valve V , which may be an ordinary receiving valve. One side of the coil L_2 is connected to the grid G and the other side is connected to the negative terminal of the six-volt accumulator B_1 . A rheostat R may be provided, but it will generally be suitable if the filament is connected directly across the six-volt accumulator. Across the coil L_3 is connected the microphone M which may conveniently be a standard Post Office microphone, preferably mounted on a wooden handle.

We now come to the question of the high tension supply. If you are lucky enough to possess D.C. mains, these may be used. It will usually be found that either the positive or negative of the D.C. mains is permanently connected to earth in the lighting system. In the present case the positive terminal was permanently connected to earth so that all that had to be done was to connect the negative terminal to the positive terminal of the accumulator B_1 . A tumbler switch might conveniently be inserted between the negative terminal of the mains and the accumulator. The best method of procedure is to take two leads from a ceiling rose, or from a plug inserted in the socket of a lamp fitting and to try connecting one of the wires to the positive terminal of the accumulator B . If the filament is bright enough and the coupling between L_2 and L_1 suitable, oscillations should be set up by the valve. Owing to commutator ripple a buzzing noise should be heard in a tuned receiver placed close to the aerial. This buzzing noise should produce a maximum sound at a certain tuning of the receiver.

Adjusting the Circuit,

If the valve is not oscillating try the other lead from the electric light and connect it to the positive side of B_1 . If the valve will not oscillate now it will be fairly conclusive that the negative side of the mains is permanently connected to earth in the system. This would mean that a negative potential instead of a positive potential would be applied to the plate with

the result that the valve would not oscillate. If this is the case the Fig. 3 circuit should be tried. This circuit does not differ in principle from Fig. 2, but it simply arranges for the mains to give the plate a positive potential. It will be seen that the bottom end of C_1 is now not connected to the earth proper, but to the positive terminal of the mains. The positive terminal of the accumulator B_1 is now connected to the special earth of the wireless station.

Having seen that the filament is bright enough,

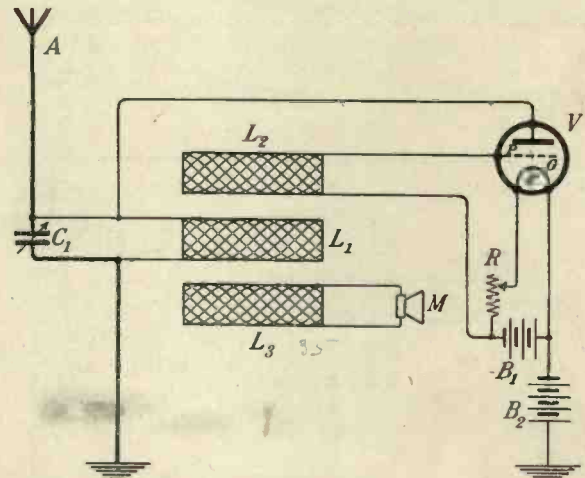

Fig. 2. Connection of circuit when positive main is earth connected.

and the coupling between L_1 and L_2 sufficiently tight, there should now be no reason why the valve should not oscillate. When it was stated that the positive terminal of the mains should be connected to the bottom side of C_1 it was, of course, understood that the correct connection was to be found by trial. First one lead from the electric light should be connected on to the bottom side of C_1 , and if the valve does not oscillate the other lead should be tried. Whenever testing the valve to see if it will oscillate it is most important at each test to try reversing the leads to the grid L_2 in order to get the reaction effect the right way round.

In both Figs. 2 and 3 the mains are shown as B_2 . All that we are really concerned with in Fig. 2 is the negative terminal of the main, and in the case of Fig. 3, the positive terminal. Although an earth is shown made to one pole of the mains, yet this is not a special earth provided by the experimenter, but actually exists in the wiring system. If there is any doubt as to whether one of the poles of the mains is connected to earth, take an ordinary incandescent lamp and connect one of its terminals to the wireless earth.

The other terminal is now connected by means of a wire to each pole of the mains in turn. If one of the poles is earthed, the lamp will light up when the unearthed pole has the connection made to it. If nothing at all happens, neither pole of the mains is earthed, and the D.C. mains may therefore be used in the ordinary way as a high tension battery.

The Use of Batteries.

When batteries are employed, the voltage may be anything from 100 volts upwards. It is even possible to make a valve oscillate and transmit over short distances on about 50 volts, but 200

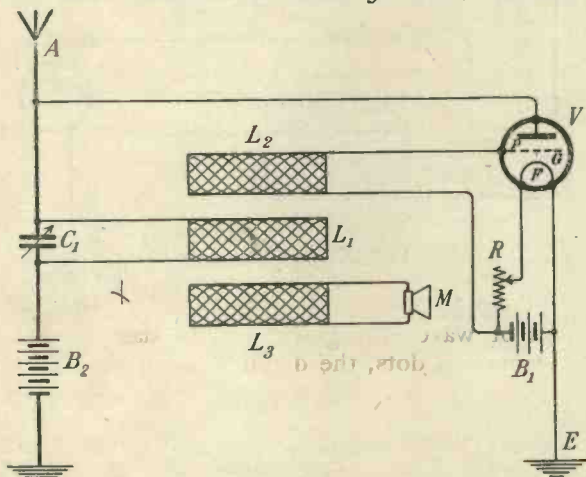

Fig. 3. Method of connecting when negative terminal of the mains is connected to earth.

volts and upwards will usually be desirable. If batteries are employed, either Fig. 2 or Fig. 3 may be used. In the case of Fig. 2, as there is now no natural earth connected to the positive terminal of B2, this terminal is connected to the wireless earth E. Likewise, in Fig. 3 the negative terminal of B2 is connected to the Wireless

earth E. In all cases an improved result will generally be obtained by connecting a fixed condenser between the bottom of C1 and the positive side of the accumulator. This fixed condenser may have a capacity of 0.002 mfd. but its value is not of any importance. When mains are employed the commutator ripple effect may be lessened by making this condenser of large value, say 1 mfd, or one half mfd.

Operation of the Set.

There are three adjustments to the set. There is first of all the tuning of the aerial circuit by means of the condenser C1 to the desired wave-length; then there is the correct adjustment of the reaction coil L2, and finally the correct coupling between the microphone coil L3 and the main inductance L1. Having got the radiated wave-length correct and keeping the inductance L3 well away from L1, the reaction coil L2 should be brought close to L1 and should occupy such a position that the maximum radiation is obtained. Some indication of the radiation will be given by the buzzing note due to commutator ripple which may be heard in the receiver.

The coil L3 should now be brought closer to L1 and the loudness of speech tested by speaking into the microphone M. It will usually be found that when L3 is brought close to L1, it will be necessary to bring the reaction coil L2 a little closer to L1 to get the loudest speech. A little practice with this simple set will enable excellent results to be obtained. Care should always be taken to see that the wave-length is correct. If it is desired to work on about 200 metres wave-length three No. 25 coils may be employed, and the condenser C1 connected in series with the aerial.

DO YOU RECEIVE THE NEWS BULLETINS ?

THOSE who desire to receive news bulletins in morse have at least five opportunities of doing so during the twenty-four hours. The arc station at Leafield may be heard anywhere very loudly on a single valve. He sends five news bulletins a day on C.W. on a wave-length of 8,750 metres.

The first bulletin is sent at 1.50 a.m., G.M.T., on behalf of the Radio Press, the publishers of this journal.

About 600 words are sent. Sporting, Stock Exchange and general news items are included in the programme, which lasts about 40 minutes. The speed is about 15 words per minute.

Further programmes are sent out at noon, 4 p.m., 8 p.m. and midnight by Leafield, on the same wave-length, on behalf of the Foreign Office. These news items are chiefly political.

THE OUTLINES OF WIRELESS

By Lt.-Col. C. G. CHETWODE, CRAWLEY, R.M.A., M.I.E.E. Deputy
Inspector of Wireless Telegraphy, General Post Office.

This article will be found especially interesting by those who are just starting wireless.

WIRELESS communication is carried out by transferring energy from one place to another by means of waves in the intervening space. The energy which produces light or heat is transmitted in an exactly similar manner, but in their case, seems much less mysterious, because we can detect, with our senses, the presence of these waves, whereas we cannot detect the wireless waves. Where then is this similarity? It is that the waves in each case are waves in the ether, the all pervading medium which we are assured exists everywhere throughout the whole universe.

The energy which produces heat and light is radiated in the form of waves in this ether, just as the energy of a stone dropped into a pond is radiated in the form of waves in the water, the waves consisting of movements up and down of the little particles of water. The transference of energy by this means, whether in the form of light, heat, or wireless waves, takes place at a speed of about 186,000 miles a second, that is, instantaneously for all practical purposes so far as radiation over the earth is concerned, though, of course, very far from instantaneously when the stupendous distances of astronomical space are being considered. The speed of travel, therefore, over the earth we may consider the same for light, heat, and wireless waves, viz.: instantaneous, but the rates, or as they are usually called, the frequencies, of the ether movements which produce the waves are very different. The more rapid the movements, that is, the higher the frequency, the shorter are the waves, the length of a wave being the distance from the crest of one wave to the crest of the next one. The most important similarity, therefore, between light, heat, and wireless is that they all consist of ether waves travelling through space at the same speed, and the most important dis-similarity is in the lengths of those waves. The highest frequencies, i.e., the shortest ether wave lengths, produce the Rontgen or X-rays, then come the Actinic rays, which are used in photography, and then the visible light rays at frequencies of about 1,200 billions a second for those which produce the sensation of violet light, down through indigo, blue, green, yellow and orange, to some 600 billions a second of red, and then further down

through the frequencies which produce heat rays until at last are reached the wireless waves with frequencies of from a few thousand to a few million oscillations a second.

It is clear, therefore, that the process of signalling by light, by means, for example, of a flashing lamp, must be similar to some extent to that of signalling by wireless. Take, for instance, the process of signalling by a flashing lamp. Each flash consists of a series of ether waves radiated, in all directions at a speed of 186,000 miles a second, long flashes being noted by readers anywhere within range as dashes, and short flashes as dots in the Morse Code, in which each letter or figure consists of dashes or dots, or a combination of dashes and dots. In wireless, it is very similar, the ether waves, as before, being radiated in all directions at the same speed, long series of waves being received as dashes, and short ones as dots, the disturbance of the ether becoming weaker and weaker as the distance from the source increases.

How then are these long ether, or wireless waves produced, and how are they received? Ether movements, which take place at a rate suitable for the radiation of wireless waves, are produced by an electric current oscillating to and fro at that rate. This fact was fully demonstrated for the first time by Professor Heinrich Hertz in Germany thirty-five years ago, and that year, 1887, may well be considered as the date of the birth of wireless, or, as they are often called, Hertzian waves. If we cannot in this country take credit for the birth, we can certainly do so for the earlier work which led up to Hertz's famous experiments. To lay claim indeed to this earlier work, we need mention only two names, two of our greatest electrical pioneers: Michael Faraday, who in 1831 discovered electro-magnetic induction, the foundation of all electric signalling, and Clerk Maxwell, who in 1867 laid down the fundamental theory of electro-magnetism, and predicted the possibility of producing these electric, or Hertzian waves.

The methods used by Hertz, for producing an oscillating electric current suitable for the production of wireless waves, was by means of an electric spark. This method of producing the waves was called the Spark System, and is still

used in most of the installations fitted on board ships, and at many small stations. The possibility of so using it was first foreseen and practically demonstrated by Senatore G. Marconi, who produced the oscillating current in an elevated wire, called the antenna. Senatore Marconi, who is universally known, and rightly known, as the inventor of wireless signalling, commenced his famous investigations at his father's home in Italy in 1895. Again, we cannot claim the great inventor as a fellow countryman, though we can at any rate boast that on his mother's side, he is of Irish descent.

Within the last ten years or so, three other systems, besides the Spark system, have been developed. The first in the field was the Arc System, where an electric arc, similar to the arc used for lighting purposes, was substituted for the spark. This arrangement was patented by Valdemar Poulsen, of Denmark, in 1903, and is based on work done in this country by W. Duddel some six years before. Many large stations are fitted with this system, including those near Oxford and Cairo, the first two stations of our Imperial Wireless Chain. Then came the Alternator System, where the oscillating currents in the antenna are produced by a high speed electrical alternator. This system was first developed in Germany, the United States of America, and more recently in France. Like the Arc System, it is fitted in many high power stations throughout the world.

Lastly we come to the Valve System, which is used extensively in small installations, including the new broadcasting stations. The Valve is similar to the ordinary electric light bulb, but contains two metal elements inside the bulb in addition to the filament of the lamp. The Valves used in sending stations are much larger than the usual electric lamp, and are connected up electrically in such a way as to produce the required oscillating currents in the antenna. It is a most efficient transmitter, not only for small stations, but also for large stations, though in the latter case, little commercial experience has been gained.

For sending messages by wireless telegraphy, a signalling key is used, so arranged that by pressing the key for long and short periods, waves are radiated into space, and work the apparatus at the receiving station so as to produce the dashes and dots respectively of the Morse Code, either as long and short buzzing sounds in the telephone receiver, or as long and short strokes on a paper tape. In the case of wireless telephony, a continuous stream of waves, modulated by the voice instead of being interrupted by a signalling key, is radiated into space, the modulations, i.e., the note, being heard at the receiving station in a telephone receiver, instead of long and short buzzing sounds as in the case of telegraphy.

The reception of wireless messages depends, primarily, on the fact that Hertzian waves, on meeting any electrical conductor, produce in it oscillating electric currents similar, though, of course, much weaker, than those by which the waves were produced at the sending station. The conductor at a receiving station consists of an antenna, as in the case of a sending station, and in small installations, such as those in ships, the same antenna is used for both purposes, being connected up to the sending or the receiving instruments as required. The actual receiving arrangements consist, therefore, of an antenna connected to apparatus, which can record in some way or other, the fact that these very weak oscillating currents produced by the waves from the sending station, are present in the antenna. Various devices have been tried, but the one now in general use is a Valve, much smaller than, but otherwise similar to, a transmitting Valve. The receiving Valve is smaller than an electric light bulb, and like the transmitting Valve has been developed from a suggestion made by Dr. Lee de Forest in 1906 in the United States of America. This suggestion, viz., to add a second metallic element to the original Valve which had been invented by Dr. J. A. Fleming in London two years before, revolutionised wireless telegraphy, and changed wireless telephony from an expensive toy to a commercial possibility.

BOOKS FOR THE BEGINNER

There will no doubt be a number of readers whose knowledge of the elements of wireless is very small and who desire to obtain the required information with a minimum of effort. Two books, "Wireless for all" (6d. net) and "Simplified Wireless" (1/- net), published by Radio Press, Ltd., and written by the Editor of "Modern Wireless," will be found easy reading. "Simplified Wireless" is a sequel to "Wireless for All," and also gives constructional details of broadcast receivers



The apparatus used in the experiments described below.

Double Reaction: A New Development

The following is the first published account of a new invention due to Mr. John Scott-Taggart. Unlike many inventions it is of immediate and practical interest to experimenters.

DURING the last year, two circuits of great value to the experimenter have received considerable attention in the technical press and by manufacturers. These circuits employ a tuned anode circuit acting as a so-called rejector circuit, the anode of the first valve being connected through a grid condenser to the grid of a second valve. A reaction coil is included in the plate circuit of the second valve and is coupled to either the rejector circuit or coupled to the grid circuit of the first valve. These two circuits were first described in "Thermionic Tubes in Radio Telegraphy and Telephony," published on July 1st, 1921. Later in the year a great deal of interest was aroused by a most valuable paper by Frank C. Phillips on this class of circuit.

A new development has now been made, and is particularly applicable to the original rejector-with-reaction type of circuit. The novel circuit

has been called a double-reaction "circuit" for want of a better name. The chief principle involved is that reaction is applied twice to the receiving circuit. The actual set on which experiments were carried out is shown in the photograph. The essential arrangement consists of the two valves on the right, with their associated circuits, the two valves on the left being used purely as low-frequency amplifiers. It will be seen that interchangeable coils are employed, tuning being effected by means of condensers. Of course, variometers or other methods of tuning might be adopted.

One form of circuit is shown in Fig. 1. A direct coupled aerial circuit is shown. In the plate circuit of the first valve is the so-called rejector circuit $L_2 C_2$, tuned to the incoming wave-length. The bottom end of L_2 is connected through the grid condenser C_3 to the grid of the valve V_2 . Instead of having a reaction coil in

the anode circuit of the valve V_2 and coupling this coil either to the inductance L_1 or the inductance L_2 , it is now arranged that reaction is introduced, not only into the circuit $L_1 C_1$, but also into the circuit $L_2 C_2$. This is effected by having two variable reaction coils L_3 and L_4 , L_3 being coupled to the inductance L_2 and L_4 to the inductance L_1 , each being so coupled that a reaction effect takes place. It is very important to see that the connections to the coil L_4 and L_3 are the right way round. This should be tested as follows:

Short circuit L_4 . Tune the aerial circuit and the rejector circuit until the loudest signals are obtained, the coupling between L_3 and L_2 being kept very loose; then bring L_3 up to L_2 and note if an increase in signal strength is obtained, the circuit $L_2 C_2$ being carefully adjusted at the time.

If signals are increased in strength all is well, but if they are decreased, the connections to the coil L_3 should be reversed. Now short circuit the coil L_3 and bring the coil L_4 close to L_1 . The signal strength obtained should increase provided C_1 and C_2 are correctly adjusted. If the signal strength is decreased, the connections to L_4 should be reversed. It is as well to point out that it is no use merely reversing the coil in the case of replaceable units.

Now unshort the coil L_3 and have both couplings loose. Bring L_3 closer to L_2 , at the same time carefully adjusting the condenser C_2

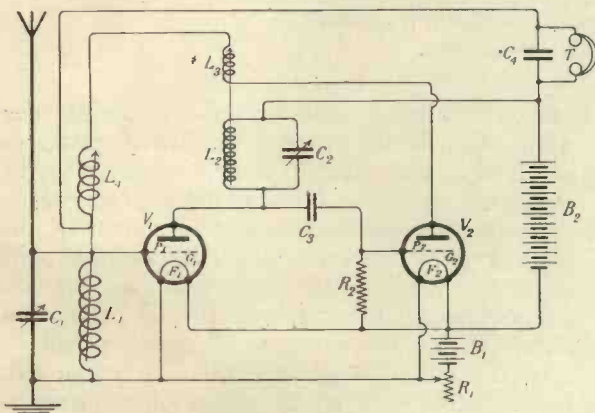

Fig. 1. Reaction is applied to the aerial circuit and the rejector circuit by two reaction coils connected in series.

to keep the strength of signals at a maximum. A point will be reached when the valve V_2 will oscillate, and this should be just prevented in the usual manner by adjusting the coupling between L_3 and L_2 . The inductance L_4 is now brought closer to L_1 and the circuit $L_1 C_1$

is carefully readjusted until the loudest signals possible are obtained without oscillation setting in. It will be found that the aerial tuning becomes very much sharper. The best results are obtained by carefully adjusting the coupling between L_4 L_2 , and the two reaction coils, the condensers C_1 and C_2 always being carefully adjusted to get the loudest signals without self-oscillation being produced.

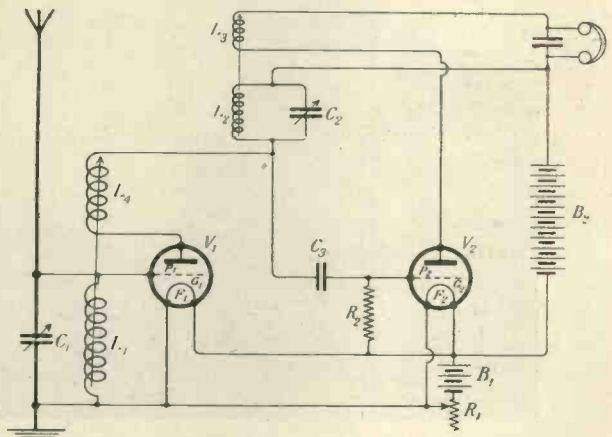

Fig. 2. Another arrangement in which each valve provides its own reaction.

It will be found that tightening the reaction on the first valve between L_4 and L_1 will simultaneously increase the reaction between L_3 and L_2 and an even balance must be obtained so that there is no self-oscillation. It will be found that either the inductance L_4 is loosely coupled to L_1 , and L_3 tightly coupled to L_2 , or vice-versa, or an average couple of each is necessary. Experiments in individual cases will very soon indicate which is best. Fig. 2 shows another arrangement in which the reaction coils are not connected in series. Instead, the first valve provides its own reaction on its grid circuit and the second likewise. A reaction coil L_4 is used for obtaining the reaction on the first valve, and a reaction coil L_3 is also coupled to the rejector circuit $L_2 C_2$. The method of operating this circuit is similar to that employed in connection with Fig. 2. Fig. 3 shows the exact arrangement illustrated in Fig. 1. It will be seen that the circuit is very similar to that of Fig. 2, the only difference being that two low-frequency valves are introduced.

The results obtainable with double reaction are, in nearly all cases, very much better than those obtainable by the ordinary arrangement in which one reaction coil only is employed. The theory of operation, and the reason for the effectiveness of this class of circuit seems to be

as follows. In the ordinary two-valve circuit employing a tuned rejector circuit as a means of coupling the valve when reaction is introduced from the second valve plate circuit to the rejector circuit, there is no effective reduction of the damping of the aerial circuit. Consequently, the tuning of this circuit is fairly flat and the benefits of reaction, as regards tuning and signal strength, are not felt on this circuit. They are, however, obtainable in the rejector circuit. If now we couple the reaction coil, not to the rejector circuit, but to the aerial circuit, reaction will be introduced into the aerial circuit, producing increased strength in signals and also on to the rejector circuit by virtue of it being in the chain of amplification. Whenever reaction is introduced from the last valve in an amplifier to the first valve, all the intermediate circuits forming the coupling chain derive some of the benefit of reaction.

The advantages of the double reaction circuits seem to indicate that the reaction cannot be effective both on the aerial circuit and the rejector circuit to the best effect. If aerial circuits and the rejector circuits have different degrees of

increased in the ordinary way, oscillation will immediately be set up in the first circuit, and the arrangement is useless for reception. Put in other words, the circuit oscillates long before the maximum signal strength is reached. By means of double reaction, however, separate reaction is applied to the aerial circuit and to the rejector circuit and the damping of each is reduced to

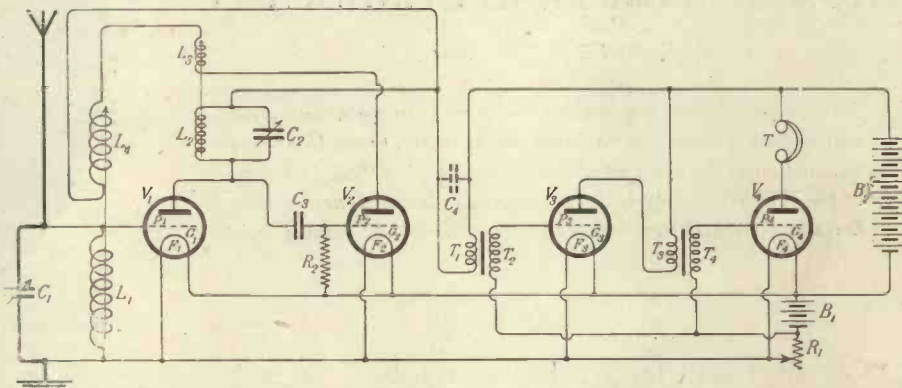

Fig. 3. A circuit similar to that shown in Fig. 1, two stages of audio-frequency amplification being added.

the critical value preceding self-oscillation.

Under these conditions we do not have one circuit having almost zero damping, and the other having a large amount of damping, but we have both of them working with a damping in the neighbourhood of zero, so that absolutely the greatest amplification is obtainable without premature self-oscillation. The principle of double reaction may be applied to all kinds of

CIRCUIT.	COIL.
Aerial Inductance	De Forest No. 25 and No. 35.
Coil reacting on Aerial Inductance ..	De Forest No. 50.
Rejector circuit coil	De Forest No. 50.
Coil reacting on rejector coil	De Forest No. 75.

Fig. 4. Table showing suitable sizes of coils, for use in the above experiments.

damping, and even if we apply the same amount of reaction to each circuit it is not possible to make both circuits have a damping approaching zero. It is true that the damping of both circuits will be reduced, but while one of them is reduced to the point just preceding self-oscillation, the damping of the other one may be lessened to only a fraction of what might be obtained by increasing the reaction. If this reaction is

other circuits employing any number of valves. Next month we intend to give some further details of double reaction and its possibilities. Meanwhile, we would be interested to hear from any experimenters who have tested out these circuits. The coils and inductances which were found suitable for wave-lengths between 300 and 500 metres are shown in the accompanying table.

AN AMATEUR WIRELESS SOCIETY

HOW TO FORM AND CONDUCT IT

By F. HOPE-JONES, M.I.E.E.

There is probably no one in this country who can speak with greater authority on the subject of radio societies than Mr. Frank Hope-Jones, M.I.E.E., who for many years has so ably held the office of Chairman of the Wireless Society of London (now the Radio Society of Great Britain). Enthusiasts will find sterling advice in the following article.



FRANK HOPE-JONES, Esq., M.I.E.E.

YOU are taking up Wireless as a hobby, applying for an experimental licence, erecting an aerial and fitting up a Receiving Set. You are full of questions and you soon hear of a neighbour attacked with the same germ to whom you can put them. He knows others, and without a thought of it you suddenly find yourself in a group or nucleus which breeds a Wireless Society. That is the way most societies begin. The idea once mooted, the group expands; some amateurs of distinction in the neighbourhood, one of whom may perhaps be a Transmitter is consulted, and from this larger circle there will be some who fall naturally and acceptably into the leadership, owing to public spirit, technical ability, or social position. It is now decided to start a Society, but you will first satisfy yourself that there is no other society formed, or forming, in your town or suburb. If there is, then spare no pains to absorb it, or put your pride in your pocket and let them absorb you. Nothing could be more regrettable than duplications or rivalry.

That matter settled, we will assume you are ready to call a preliminary meeting. Announce it in the local newspapers and the various wireless Journals, remembering that the latter usually go to press a week or more before publication, and put up notices in the Library, the Town Hall, the Literary Institute, or other public buildings. A drawing-room might well suffice for such a preliminary meeting, particularly if the hostess will entertain to dinner some neighbouring wireless star, or man of affairs to take the Chair. Your local M.P. or Mayor should

be held in reserve for a later and more public occasion: aim rather at a good business man capable of focussing debate upon an Agenda, which should be somewhat as follows:—

- Title.
- Amount of Subscription and Entrance Fee.
- Classes of Membership.
- Club Rooms.
- Places and dates of meetings.
- Election of Committee and Officers.

With regard to the classes of membership, in view of Broadcasting and its following of frankly non-technical knob-tuners, you may think it desirable to have two classes: MEMBERS, consisting of those for whom the Society was primarily intended, namely, genuine experimenters with considerable technical knowledge, and ASSOCIATES, whose sole qualification would be that they have either got a Broadcast Licence or have applied for one. Some may say that the Subscription of the latter should be less, others that it is a mistake to favour those who are too ignorant or lazy to master the elementary technicalities of radio-science; a keen enthusiast would rather look upon Associateship as the class for the idle rich, and let their subscriptions subsidise the more brainy members of the Society.

Such a debate will show what stuff your meeting is made of and reveal who's who in the company present. The promoters should sit together at the Chairman's table, and the election should be left until the end of the meeting, by which time it is to be hoped that the Chairman's tact will have persuaded most of those present

to speak, and thus enable him and the founders to discriminate between the tradesman, out for notoriety, and the gentleman who goes into such an enterprise thinking of what he can give rather than what he can get out of it.

Don't fill up all the vacancies at once; you are certain to find some specially competent man in the course of the first few weeks whose services you will want to secure. Your President may well be some "Big Pot," who is only expected to turn up on great occasions, and your Vice-Presidents, some men of distinction in science, who could not well be expected to attend your Committee Meetings, but might be good for a Lecture occasionally. The all-important appointment is, of course, that of a Secretary. Your choice will not necessarily fall on a man of leisure, because it is a truism that only a busy man knows how to find time to carry out his responsibilities. He should have type-writing facilities and a telephone, and that usually implies that he should be in business on his own account. With quite a trivial addition to her daily duties, a typist can summon Committee Meetings with notices reproduced by carbon copies and provide all the machinery of the Secretariat of a small Society at a trivial cost. She would keep a postage book, which would also record the cost of mimeographed circulars, membership application forms, and similar work sent out, thus relieving the Hon. Secretary of the cost of everything except her services and the telephone calls, which he probably would not feel. It is safe to say that no one should accept this arduous post without some such facilities.

The first duty of the Committee will be to frame the Rules. When enough is known of each other's abilities a sub-committee may well be appointed for this task, and should there happen to be a Solicitor present, he will be on it. Write to the Secretary of any well-known Society, such as The Radio Society of Great Britain, for a copy of their rules, and frame your own on any such model considered appropriate, always remembering, however, that greater simplicity and brevity should suffice for your society than for a large Institution.

The last item on the Agenda at the preliminary meeting may be to select the date of the Inaugural Meeting, to which these rules will be submitted for approval. A concert room, school, or small hall should be hired, and the Chair should be occupied on this occasion by the President, who announces his acceptance of the Office, and expands upon the objects of the Society. The various Officers and the Committee, who, up

to this time, with due humility, consider themselves more or less self appointed, are confirmed in their Offices, and a programme of Lectures will be announced, or at any rate, a list of names of those who have undertaken to give them. Doubtless there will be other announcements regarding club rooms and their equipment, as well as the latest news of broadcasting.

The Society may now be said to be fairly launched, and the reports of this meeting which you, or the Secretary, will supply to the local press and the Wireless Journals, will complete your publicity plans for the present and will suffice to give you confidence that fresh recruits will seek you out, and that there is no risk of any other Society being started, owing to ignorance of the existence of your own. Never despise publicity, even in the conduct of the Society after it is established. Let the Editor of your local paper get into the habit of applying to the Secretary for the latest news of Broadcasting programmes, and let it also be a habit to contribute to the newspapers a short paragraph in description of each of your more important meetings.

If you get the right men in the right offices you will soon settle down to automatic and smooth running. You are not likely to experience much difficulty at first in arranging programmes for your meetings. It is well to allocate one evening at an early date to an exhibition of home-made apparatus, giving each member ten minutes for a description of his own. When you begin to lack subjects for discussion you can exchange compliments and lecturers with neighbouring societies. In this connection, affiliation with The Wireless Society of London, which has recently changed its name to The Radio Society of Great Britain, may help you, as they circulate lists of distinguished amateurs in all parts of the country who are willing to lecture. There are other advantages of affiliation, but the usual motive of sending up the Society's name is not what can be got out of it, but rather a patriotic one, to strengthen the hands of the central body in their negotiations with the Government.

Finally, avoid self advertisement, petty jealousy and quarrelling, as the plague. Let each one give of his best and let him who contributes most, and with most success, be especially careful to guard against domineering and making the society a "one man show." Perhaps the best safeguard against this is to insist on democratic control by means of real elections at your annual meetings.

DIRECTIONAL WIRELESS

By J. ROBINSON, M.B.E., Ph.D., M.Sc., F.Inst P

Dr. Robinson, the inventor of the direction finding system which bears his name, and which for years has been used on service aircraft and also on numerous ships, has written for us a series of articles on this important subject. Future issues of "Modern Wireless" will contain longer articles from his pen.

MOST people who have any touch with, or interest in wireless are aware that it is not merely of use in the transmission of messages or in broadcasting, but that there are other uses which had great influence on the course of the Great War. One of these is the determination of the direction of transmitting stations.

This application of wireless was of such enormous importance to all combatants during the war that many of the nations taking part in it, and also neutrals, devoted much attention to it, to find improved methods of determining the direction and location of enemy transmitting stations, methods for enabling their own ships and aircraft to determine their positions; also to see whether it was possible to devise transmitting stations whose direction could not be determined. The development has gone on since the war, and at the present time we are in the position that bearings of transmitting stations can be relied on with a great deal of certainty. Much more remains to be done to get into a position such that absolute reliance can be placed on wireless direction finding, so that every ship will determine its position by wireless; also every aircraft.

At present ships have means other than wireless for determining their position and usually these means are sufficient. There are occasions when a ship cannot depend on these methods for position finding, particularly in the case of fog. With aircraft there are many more circumstances than in the case of ships when the ordinary means of navigation are insufficient. For instance, when flying above clouds, all landmarks are invisible, and the unknown factor of drift may be so considerable as to carry an aeroplane or airship many miles off her course. It is thus very desirable to have directional wireless systems developed to the stage of perfection where they will be easy of installation and operation, and where navigators of ships and aircraft will rely on them as they now rely on the magnetic compass.

At the present time navigators use wireless bearings, and they are in the condition of being educated in this respect. The time is not far distant when they will rely completely on these bearings and when their first thought will be the

condition of their wireless apparatus, knowing that with this in good condition they will be certain of their position and so can guarantee the safety of the ship.

There is some similarity between the use of the magnetic compass and of directional wireless. A magnetic compass indicates one direction on the surface of the earth, that being the direction to the north or the south magnetic poles. Directional wireless gives the direction to any transmitting wireless station, so that if a ship carries directional apparatus, various directions can be determined and the actual position of the ship found. Again, if the ship does not carry directional apparatus, but has an ordinary transmitting set, it can transmit and ask for its position, various direction finding stations on land obtaining bearings, communicating these bearings to a central station where the ship's position can be worked out and transmitted to the ship.

These are two methods by which a ship can determine its position, but there is still another way, which is to have actual directional transmission stations at fixed known places. Such beacons send out waves from their aerial system which are more intense in one direction than in others. The whole beacon system is caused to rotate very much in the same way as a lighthouse beam, and thus, to anyone who knows the particulars of rotation, it is easy to determine the direction of the beacon. These various systems will be described in more detail in their proper place in the following articles of this series.

There are many methods of determining the direction of a transmitting station, and almost the whole of them depend on the same fundamental principle, namely, that the strength of signal received from any transmitting station by an aerial loop depends on whether the plane of the loop is pointing towards the station or is at right angles to it. In fact, such a loop aerial is the simplest form of direction finder, and most other forms are adaptations of it to gain special advantages, such as obtaining louder signals, or avoiding having to rotate large moving parts. Thus, by explaining the use of the simple loop direction finder the fundamental principles of the subject will be grasped.

(To be continued in our next issue.)

HOW TO MAKE A SIMPLE BROADCAST RECEIVER, USING A CRYSTAL DETECTOR

The following article explains fully how a simple but effective receiver for broadcasting may be made from start to finish for a nominal sum and with the simplest tools.

A SIMPLE broadcast receiver consists of five essentials: (a) an aerial, (b) an earth, (c) a tuner, (d) a detector, (e) a pair of telephone receivers. The aerial may consist of a 100 foot length of, say, No. 20 S.W.G. bare copper wire erected as high as possible, one end being brought into the window of the room in

wise secured to a piece of sheet tin buried in the ground outside the window. This earth might instead be in the form of water pipes to which the bared end of the earth lead may be secured.

The tuner, which is about to be described, consists of what is known as a *variometer*. It is

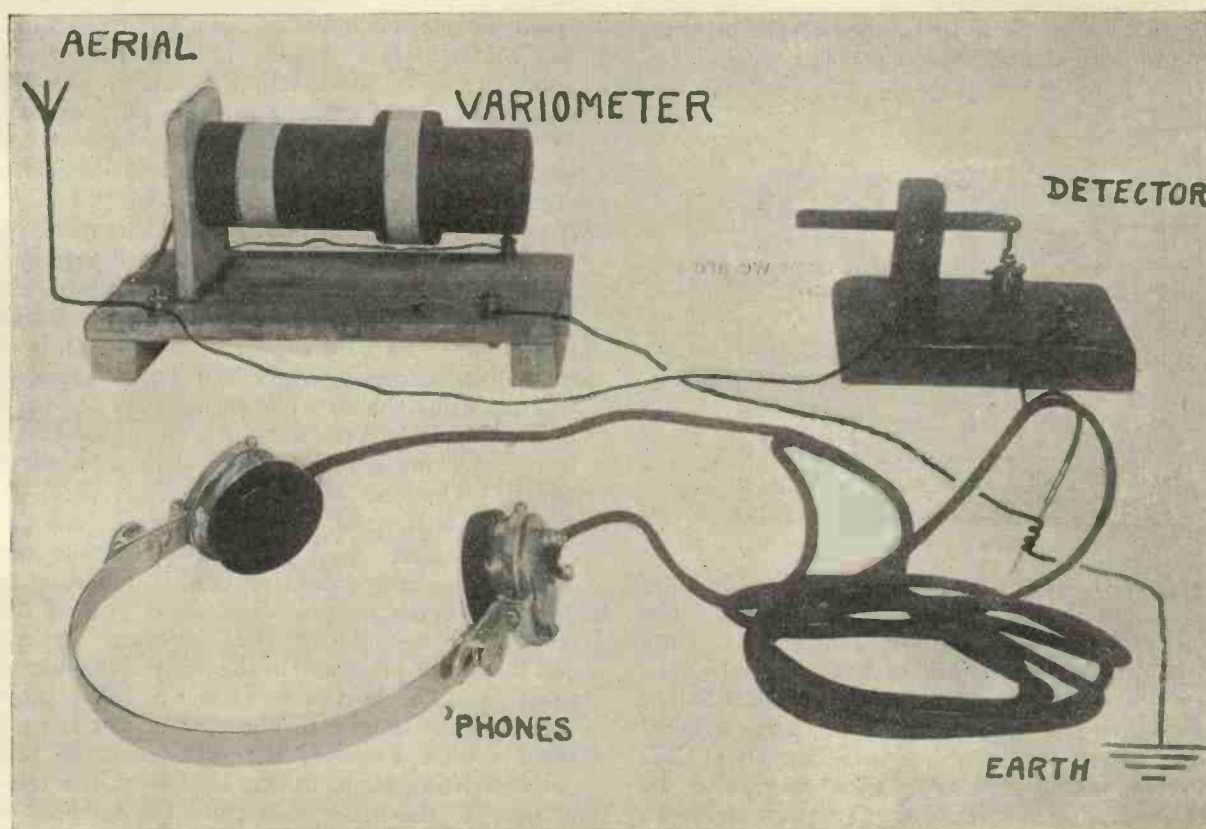

Fig. 1. Illustrating the arrangement of the broadcast receiver.

which the broadcast receiver is to be installed, care being taken to see that the wire, as it enters the room, is insulated from surrounding objects. A piece of insulated bell wire might be joined to the lead-in of the aerial just outside the window.

The earth may be an insulated wire, say No. 20 double cotton covered copper wire, which is bared at one end and soldered or other-

really two coils of insulated wire wound on separate cardboard tubes and connected together. These two coils are made to bear a different relationship to each other so that the receiver circuit may be tuned to the wave-length of the incoming signals.

The crystal detector may be made very simply, or, on the other hand, a good deal of work may be

put into constructing a nice-looking piece of apparatus. Generally speaking, the results obtainable by more elaborately constructed apparatus are no better than those obtainable with a very simply arranged set. With many, however, appearance and ease of operation are important factors, so that we are giving two kinds of broadcast receiver which may be made. Both have given excellent results in practice, and the construction of either may be embarked upon with every confidence.

Fig. 1 is a photograph of a simply constructed but effective broadcast receiver. The tuner, which takes the form of a variometer, is shown on the left, while the crystal detector is on the right. The telephones are in the foreground.

Fig. 2 shows a much simpler arrangement, in which two cardboard tubes, A and B, are wound with double cotton covered wire of No.

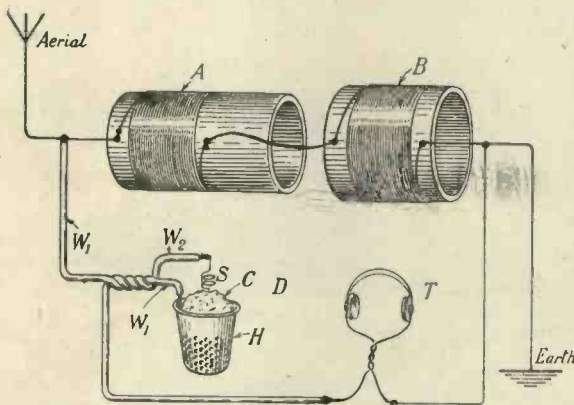

Fig. 2. A very simple form of broadcast receiver.

36 S.W.G. (standard wire gauge). The two tubes are illustrated in detail in Fig. 3. The dimensions of the cardboard tube Fig. 3a are as shown. The length of the tube is 6 ins., and the diameter 2 ins. These cardboard tubes may be purchased from any wireless dealer, from whom a $\frac{1}{4}$ pound No. 36 D.C.C. (double cotton covered) wire may also be obtained. Two small holes are first made in the tube at the point marked H₁, about $\frac{3}{4}$ in. from the left hand side of the cardboard tube. The end of the insulated wire is now passed in and out through the holes H₁ several times and tied to them so that there is a firm hold on the end of the wire. A length of wire marked W₁, about a foot long, should be left over. The tube should now be wound for a distance of $\frac{11}{16}$ in. with the insulated wire, taking care that each turn is wound close to the next turn. There should be altogether 33 turns of the wire, and

when this number has been wound, keeping the wire taut all the time, the end should be made fast to the two holes H₂ in the tube, a length W₂, of about 1 foot, being left over as before.

The second tube, Fig. 3b, is now constructed. It measures $1\frac{1}{8}$ ins. long and $2\frac{1}{2}$ ins. diameter, and is wound with 31 turns of the same wire as before, namely No. 36 D.C.C. The ends of W₁ and W₂ should be left as before.

Having wound these two coils the next thing to be considered is the very simplest form of detector which may be constructed—the crystal detector. This is shown as D in Fig. 2. The detector is constructed as follows:

A quantity of solder is melted in a thimble H. The bared end of an insulated wire W₁ is dipped into the molten solder in the thimble. A small piece of suitable crystal is also dipped into the solder before it sets, half of the crystal about being embedded in the solder. Several suitable kinds of crystals for this purpose may be purchased from wireless dealers. Good examples are Hertzite, Permanite and Radiocite. A second stout insulated wire, say, No. 20 D.C.C. is wound round the wire W₁ for a short distance, the two wires being preferably twisted together. The end of the wire W₂ is bent as shown. At its extreme end it is bared, and with this bared end is twisted a bare copper wire S which is of much finer diameter, say, No. 36 gauge. The wire S is made into the form of a spring S. The wire S may be made into the form of a spring by twist it round some sort of object such as a diary pencil. The end of the spring S is made to touch the surface of the crystal C.

The receiver may now be connected up. The wire coming from the aerial is joined on to one end of the coil A. The other end of the coil A is connected to the beginning of the coil B, and the other end of the coil B is connected to earth. The beginning of the coil A is now connected by a wire to one side of our improvised crystal detector, the other side of this detector being taken to one lead from the telephones T, the other lead from the telephones going to the earth connection.

The operation of a simple set of this description does not present any difficulties. The larger coil B is slipped over the coil A and the position of the coil with respect to A is varied until broadcasting is heard. If nothing whatever is heard, either when the coil B is slipped right off the coil A, or is in any position on the tube, the tube B is reversed and the other end of it is slipped over the tube A and the positions again varied.

Care must be taken to see that the end of the spring S is lightly touching a portion of the crystal C.

Once some sort of signals have been heard, the end of the spring S may be moved about with the hand over the crystal until the loudest signals are obtained. Careful tuning up may now be obtained by more carefully adjusting the position of the coil B.

A More Elaborate Set

The receiving set shown in the photograph of Fig. 1, is of a somewhat more ambitious character. The two inductance tubes A and B of Fig. 3, are now mounted on a special stand. This stand is constructed as shown in Figs. 4, 5 and 6. Fig. 4 shows the baseboard which measures $8\frac{1}{2}$ ins. by $4\frac{1}{4}$ ins. by about $\frac{3}{8}$ in. At each end there is a ledge of wood to keep the baseboard above

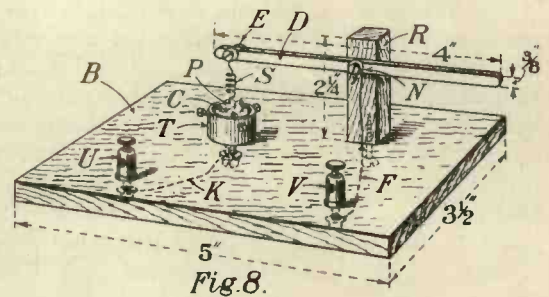
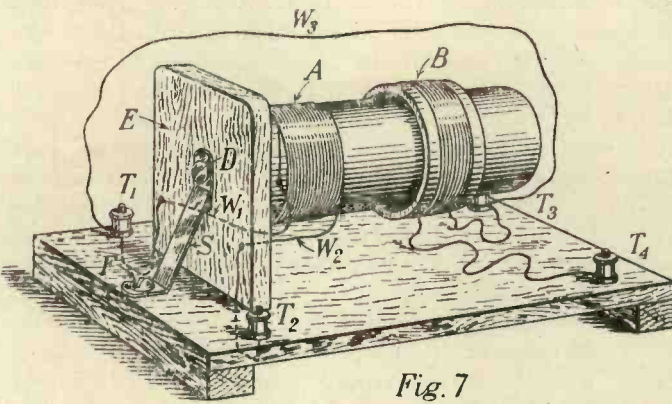
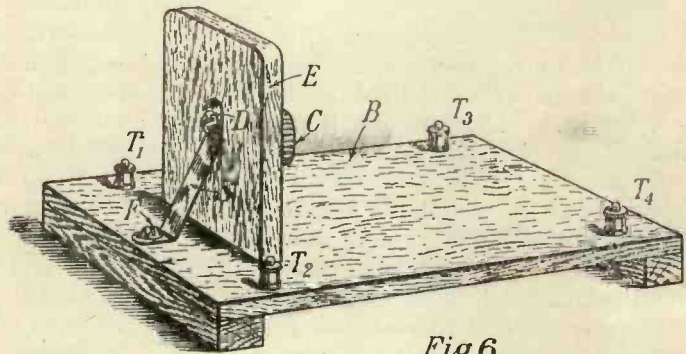
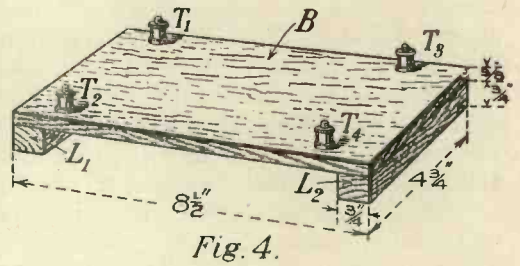
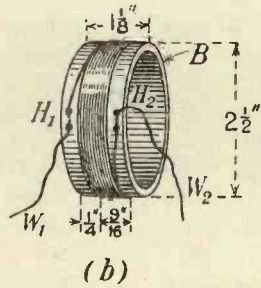
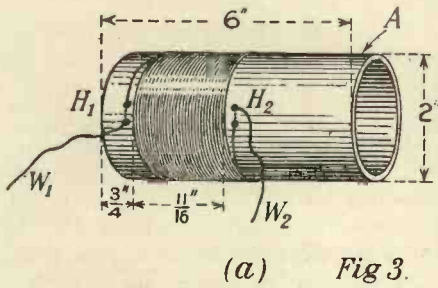

Figs. 3-8. Constructional details of the variometer, tuner and crystal detector.

The telephones used should be of the high resistance pattern. Their resistance should not be less than 1,000 ohms. It is as well to get a good well-known brand, as the telephones on a simple crystal receiver are a very important feature.

the level of the table. Both ledges, L1 and L2 measure $4\frac{3}{4}$ ins. by $\frac{3}{4}$ in. by $\frac{3}{4}$ in. These ledges may be secured to the main base board by screws, or nails, or even by glueing.

Having made the base board, the wooden support for the coil A is made. This end piece

is shown in Fig. 5. It measures $3\frac{1}{2}$ ins. by $4\frac{1}{2}$ ins. by about $\frac{3}{8}$ in. The two top corners are preferably rounded off. A piece of wood marked C and measuring $1\frac{13}{16}$ ins. by $\frac{3}{4}$ in. by 1 in. is secured to the end piece E. This piece of wood is preferably fixed to the end piece by a screw D as shown in Fig. 6. In Fig. 6 the end piece is shown mounted on the main base board B. Three screws are passed from the bottom of the base board into the bottom edge of E to hold the end piece down, but an additional support consists of a thin brass strip S measuring about $3\frac{1}{4}$ ins. by $\frac{5}{8}$ in. Two holes are made in the ends of this strip of metal which might, if nothing else is available, be simply a piece of ordinary tin. The screw D passing through the hole of one end of the strip S through the end piece E, and into the piece of wood marked C; the other end of the strip S is secured by means of the screw F to the main base board. The support S greatly increases the rigidity of the end piece E.

Four terminals, T₁, T₂, T₃, and T₄ may now be fitted in the four corners of the base board, or they might have been fitted at the stage shown in Fig. 4. These terminals may be of any suitable type, but the type shown will be found effective.

The variometer is completed by fitting the cardboard tube A over the piece of wood C and making a few necessary connections. The piece of wood marked C of Fig. 6 is slightly longer than the internal diameter of the cardboard tube A of Fig. 3, and the end of C is smeared with seccotine or glue and the tube A is forced over it. The tube A is pushed over the piece of wood C until the end of the tube is against the inner side of the end piece E. When the glue has dried the cardboard tube should be held firmly in position, but to make it more rigid a screw may be let through the cardboard tube into each end of the piece of wood C. One end of the coil of wire on the tube A is now taken to the terminal T₁, and the other length of wire is connected to the terminal T₂. It does not matter which end is taken to which terminal, nor does the exact method of taking the leads to the terminals matter. That shown in Fig. 7 will be found suitable.

The second and larger tube B is now slipped on to the end of the tube A so as to take up the position shown in Fig. 7. The two ends of the coil wound on the tube B are now taken, one to the terminal T₃ and the other to the terminal T₄. It does not matter which of these goes to which terminal, but plenty of slack wire should

be allowed so that the tube B may slide right along the tube A until it is right up against the end piece E.

The terminals T₁ and T₃ are now connected on the outside of the instrument by a piece of insulated wire W₃, and these terminals are not used again in the class of apparatus described. If this wire, however, is omitted, the piece of apparatus may be used as a loose-coupled tuner in different circuits from the one described in this article.

The variometer is now complete and the next step is to make the crystal detector.

The Construction of the Crystal Detector,

The crystal detector is shown in Fig. 8. A board B measuring 5 in. by $3\frac{1}{2}$ in. by $\frac{3}{4}$ in. has mounted on it a crystal cup T, which may be purchased for a small sum from any wireless dealer. This crystal cup is provided with a number of screws which hold in position the crystal C. A block of wood R, measuring $\frac{3}{4}$ in. by $\frac{3}{4}$ in. and $2\frac{1}{2}$ in high is screwed down to the wood by passing a large steel screw through the baseboard B from the bottom. One and a quarter inches up the piece of wood R is a screw and washer marked N. This screw acts as a pivot for a strip of brass D, which is $\frac{1}{16}$ in. thick, and slightly less than $\frac{3}{8}$ in. wide. At the left-hand end of this strip is a small nut and bolt E, the screw part passing through a hole in the brass strip. Washers on each side of the strip may be employed, and between one of these washers and the brass strip is clamped one end of the bare wire spring S of, say, No. 36 S.W.G. bare copper wire. By using a nut and bolt arrangement of this sort different kinds of springs may be employed, and, if one becomes stretched out, or otherwise unserviceable, a new one may be readily put in its place. The brass strip D is 4 in. long, and is pivoted halfway along its length. The crystal cup T is connected by a wire K (preferably under the board) to the terminal U, and a similar wire F connects the terminal V with the screw N, and therefore with the metal spring S.

The advantage of this detector is that practically any point on the crystal C may be tested by slightly moving the block R round on its screw and by moving the end of the brass strip D up or down. This last movement enables a careful adjustment of the crystal detector to be made by altering the pressure of the point P of the wire spring S on the crystal.

Connecting up The Receiver.

The method of connecting up the variometer, the crystal detector, and the telephones is shown in Fig. 1. It will be seen that the aerial lead-in is connected to one terminal of the variometer, which terminal is also connected to one of the terminals of the crystal detector. The other side of the crystal detector is connected to one lead from the telephones, the other lead from the telephones being connected to the wire which goes to earth. This wire is also connected to one of the terminals of the variometer.

Operation of The Set.

To operate the set, the spring contact wire of the crystal detector should be lowered so that it just touches the crystal. Having made this adjustment, the outer tube of the variometer is moved gradually along the inner tube until signals are heard. If, after adjusting the position of the outer tube, nothing whatever is heard, even after trying a different point on the crystal, the outer tube should be reversed and slipped on to the inner tube once more, the position of the outer tube being gradually varied. Signals should now be heard, and the loudest position

should be found by more carefully adjusting the position of the outer coil. A final adjustment on the crystal detector may now be made to get the best signals. Reversing the connections to the detector terminals touching the pivoted arm will not affect signals.

Results Obtainable.

The results obtainable with this set are quite satisfactory. It has been used in connection with a standard Post Office aerial at a distance of 10 miles from the London broadcasting station. Music and speech come in quite clearly, as do also 2 OM, 2 KT, and numerous other London Amateurs. North Foreland (GNF), Niton (GNI), and other stations come in quite clearly. The set will tune between about 300 and 600 metres.

Conclusion.

Although this is a very simple receiver, if it is constructed in two parts, namely, the variometer and the crystal detector, they may be used as units for more ambitious sets using valves, and we will refer, in future issues, to suitable valve receivers in which they may be incorporated.

BOOK REVIEWS.

"Wireless: Popular and Concise."

By LT.-COL. C. G. CHETWODE-CRAWLEY, R.M.A. (London, Hutchinson & Co.) Pp. 92. Illustrated, 1/6.

"Wireless Popular and Concise" is a book which will appeal both to the beginner and to the advanced student of wireless. Essentially, it is written for the beginner, and it is undoubtedly one of the most interesting and complete popular accounts of the history of wireless. The opening chapters deal with fundamental principles underlying the transmission of wireless messages, and lead on to wireless telephony and its reception. Special uses of wireless such as that on ships and for directional work are next discussed, the book concluding with wireless in the home. Many

excellent photographs of commercial wireless stations are included, in addition to numerous line illustrations.

"Wireless Telephony Simply Explained."

By R. W. HALLOWS (London: C. Arthur Pearson, Ltd.) Pp. 121, illustrated, 1/6

This little book has been written for the very beginner. It explains in very simple language the "how" and "why" of Wireless. About half the book is devoted to the elementary principles which are explained by a number of interesting simple analogies. The concluding chapters give constructional details of a crystal receiver, which can be made with the very simplest of tools, and at a moderate cost.

THE WORLD'S LAND STATIONS

THEIR CALLS AND WAVE-LENGTHS

NOTE.—The experimenter or operator who desires to know what stations he may expect on a certain receiver or adjustment will find the following list of great value. The stations are arranged in order of wave-lengths. Special arrangements have been made with H.M. Stationery Office to reproduce extracts from official publications. Spark stations are in ordinary type and continuous wave stations in italics.

METRES.

- 300 LEI Ingöy, LFG Spitsbergen.
LET Tjömö, LDF Flekkeröy, LGK Utsire, LGN Bergen, LFR Röst, LEN Sörvaagen.
EAB Tangier Legation, PCH Scheveningen, KAV Norddeich, KBX Cuxhaven.
KAW Swinemünde, OXA Copenhagen, OXB Blaavand, OXC Gjedser.
OXJ Thorshavn, OXK Tveraa XF Svendborg.
SAC Trällebörg, SAE Gottland (lower limit for reception only).
Alternative wave for French Shore Stations.
HCG Guayaquil, HCQ Quoto, SUB Port Said.
- 375 DSAC Trällebörg.
- 400 *PCA Amsterdam, PCE Nieuwediep, PCC, Flushing (Buffel), PCE De Mok.*
PCN Noord Hinder Lt. Sh., PCO Haaks Lt. Sh.
- 450 British D. F. Stations open to Merchant Ships.
Most French D. F. Stations.
CLZ la Carraca, Barcos-Peuenos, OXC Gjedser, OXF Svenborg.
OXL Hammeren.
GKG Heysham Harbour.
- 500 OXJ Thorshavn, OXK Tveraa, OXF Svendborg.
- 600 Universal Listening Wave (Ships).
Danish Shore Stations.
Allied Men-of-War Shore Stations Calling Wave.
OXC Gjedser, CNA Agadir, HIA, NJG S. Domingo City.
Swedish Shore Stations—except Karlsborg (Lower Limit).
OXL Hammeren, OXM Christiansö Is.

METRES.

- 650 *OXM Christiansö Is. (660).*
- 700 ATR Atbara, GMR Gambela, KMR Khartoum, MGR Mongalla, NSR Nasser.
MLR Malakal, WWR Wau.
OXL Hammeren, OXM Christiansö.
- 750 FFU Ouessant, HIA, NJG S. Domingo City.
- 800 LEJ Libau, OXB Blaavand, OXC Gjedser, IQV Tivoli (Pola).
HCG Guayaquil, HCQ Quito, Buenos Ayres.
- 850 SUH Alexandria.
- 900 Spanish Shore Stations, FSR Fasher, KER Kereinik, ZNR Kebkebia.
SXX Corfu, FF Sofia, EPU, Hapsalu Civil Aviation R/T (C.W. and I.C.W.)
Air to Ground and Ground to Air, ZM Le Bourget R/T.
- 950 HIA, NJG, S. Domingo City, NAZ Managua (952).
NPO Cavite, NPG S. Francisco, NPK Point Arguello, NPE North Head, NPL San Diego (all 952 for meteorological bulletins).
- 1,000 RGA Riga, OXC Gjedser, EWT Tartiu.
NAT New Orleans.
VPS Cap d'Aguilar, BYM Culver Cliff.
BYH Rosyth, BYK Sheerness, BYR Bunbeg, BTQ Corkbeg, BYO Rame Head.
RT Rotterdam (Lower Limit).
Certain German Shore Stations (Lower limit).
PGR Asuncion, PVC Concepcion, PEC Encarnacion.

METRES		METRES	
1,050	X Port Limon.	1,900	ELN Reval, HIA, HJG, S. Domingo City.
1,100	CCE Valparaiso, LEJ Libau.		<i>HJE Cali (proposed).</i>
1,200	Alternative for Chinese Shore Stations. Alternative for Spanish Shore Stations. IQZ Pola, ELN, Reval SXA Athens, KVO Kovno. PKC Sitoebondo, PKD Koepang, PKE Amboina, HIA, NJG S. Domingo City. VTP Port Blair, VTR Rangoon, BZQ Christiania (Ja.) BZL Demerara, SUH Alexandria. <i>DF Dusseldorf, FM Frankfort a./M.</i> <i>(Lower limit), AY Bayonne.</i>	2,000	BZF Aden, BZE Matara, BXW Seletar, BXY Stonecutters. BZK Bathurst, BZJ Port Nolloth, BZI Durban, BZG Mauritius, BZH Seychelles. EGC Madrid, SXX Corfu, SAA Karl- krona (Higher limit). SAE Cottland (Higher limit), SAH Härnösand (Higher limit). VWC Calcutta, VWK Karachi. VWB Bombay, VWM Madras. KPM, NPW Eureka. VLA Awanui, WAR Warsaw. <i>HJD Medellin (proposed), WAR Warsaw.</i>
1,250	CWA Cerrito.	2,080	<i>BYF Pembroke, BWK Kingstown, BWQ Queenstown.</i>
1,350	FUT Toulon, FUK Oran, FUA Bizerta.	2,100	EGA Almeria, EGB Melilla, EGD Ceuta, EGF Larache. EGL Cape Juby, EBV S. Fernando. EAL Las Palmas, EAT Teneriffe, EGK Tetuan (Alternative). <i>swol) bu</i> Alternative for Chinese Shore Stations. <i>GKU Devizes.</i>
1,400	HCG Guayaquil, HCQ Quito. <i>French Civil Air Stations.</i> <i>GFA Air Ministry.</i> <i>Belgian and Dutch Civil Air Stations.</i>	2,200	FL Paris, BZL Demerara. <i>HJC Baranquilla (proposed).</i>
1,500	HIA, NJG S. Domingo City, OAZ S. Christobal (Peru), NAX Colon, NAR Key West, NAJ Great Lakes (1512), NPK Point Arguello (1512). RAS Vladivostok. <i>YN Lyons, ELN Reval.</i>	2,250	ICD Rome (Centocelle).
1,590	Spanish Shore Stations (alternative wave)	2,300	PKC Sitoebondo, PKD Koepang, PKE Amboina.
1,600	PSO Posen, TOR Thorn. LFR Röst, LEI Ingöy, LFG Spitz- bergen, OJA Helsingfors. PKC Siteobondo, PKD Koepang, PKE Amboina. Alternative for Chinese Shore Stations. BZR Somerset Is., BZM S. John's (N.F), VAL Barrington Passage. Chilian Shore Stations. <i>ACA Aldershot.</i>	2,350	EAV Vigo. EAB Barcelona. NAY Point Isabel.
1,680	<i>AN Nimes, AM S. Inglevert, GFA Air Ministry, BAV Brussels.</i> <i>STB Soesterburg, ZM Le Bourget.</i>	2,400	HIA, NJG S. Domingo City (Higher limit). NBA Balboa. <i>BYE Ipswich, BYF Pembroke, BZF Adebn, BYW Gibraltar (Rock).</i> <i>NPL S. Diego, NPG S. Francisco, BZK GBathurst.</i>
1,750	GCS Caistor (1750). KAV Norddeich, PCH Scheveningen, PKX Malabang (proposed), OXA Copenhagen.	2,500	<i>EAC Cadiz, EGC Madrid (Alternative), SAJ Karlsborg.</i> <i>FL Paris, NAA Arlington.</i> <i>PKX Malabang (Lower limit proposed for Navy and Army).</i> <i>GKU Devizes.</i>
1,800	SAB Göteborg (Higher limit), SAF Vaxholm (Higher limit), HCE Esmer- aldas, VQF Kuching, VPL Trinidad, GSW Stonehaven. New Year Island, SOH Ilha do Govern- ador, SUH Alexandria. <i>PCA Amsterdam (Lower limit proposed), HJF Cucuta (proposed).</i>	2,600	FL Paris, VIA Adelaide.
		2,700	BYZ Rinella, FRX Nantes (Basse Lande) SAI Boden (Higher limit).
		2,800	MPD Poldhu. SAJ Karlsborg, NPE North Heads. <i>PCA Amsterdam (Higher limit proposed).</i> <i>VPT Malta Is.</i> [To be continued

Choosing a Broadcast Receiver

SOME ADVICE TO THE BEGINNER

By MICHAEL EGAN.

Those who are anxious to instal a broadcast receiver and have little knowledge of the subject will find their troubles solved in the following pages, which summarise the problem.

MANY thousands of people to-day are asking themselves the question: "What kind of wireless receiver shall I buy?" All they know is that broadcasting has begun at last, and that, with a suitable receiver, it is now possible to receive vocal and instrumental music by wireless. Their problem, of course, is summed up in the word "suitable." They want to know what kind of receiver will be most suitable for their own particular needs. The answer to this problem, needless to say, will vary in each individual case, and could not be treated comprehensively in a single article. I shall, therefore, confine myself to summarising some of the most important factors that influence the efficiency of any receiving equipment.

First of all, the purpose for which the wireless receiver is intended must be considered. The Postmaster General issues two kinds of receiving license: one for those who wish to receive the broadcast programme only, the other for those who intend to carry out "experimental reception." Licenses of the latter kind will only be granted, of course, to those who are qualified to conduct some form of experimental work. As the holders of these licenses may also be considered capable of choosing their own instruments, we can exclude them from consideration in this article; detailed attention is given to their needs elsewhere in this issue. Those who wish to receive the broadcast programme should apply at once to the nearest Post Office for the necessary license.

Having secured a license, the next thing is to erect a good aerial. Wherever possible, the aerial should be out of doors, and every effort should be made to combine the maximum length and height consistent with the regulations laid down by the Postmaster General. The receiving license stipulates that an amateur aerial shall not be more than about 100 feet in total length. A single horizontal 80 ft. wire, with a 20 ft. down-lead, would therefore constitute as efficient an average aerial as one may hope to erect within these limitations. If a

twin-wire aerial is employed, the wires (which should be spaced about 5 feet apart) may have a total over-all length of about 100 feet each.

Although the relative efficiencies of aerials cannot be considered here, one important fact must be noted. It is impossible to estimate the value of any receiving equipment without taking into consideration the quality of the aerial that is used in conjunction with it. A complete receiving installation may be regarded as comprising an aerial and a receiving instrument, and the total efficiency of the installation depends on the one just as much as on the other. If the aerial is a bad one, only mediocre results should be expected at the most, even when the best receiving instrument is employed with it. Similarly, if a bad receiving instrument is used with a good aerial, one cannot hope to get satisfactory results.

There is yet another important factor which affects the strength of signals that can be picked up at any particular receiving station, namely, the distance between the receiving and the transmitting station. When a wireless wave is set up by a transmitting aerial it possesses a certain amount of initial energy. As it moves across the earth that energy decreases gradually, and finally dies away altogether. The shorter the distance between the two stations, therefore, the more energy will be available to actuate the receiving instrument.

From these facts it will be obvious that the choice of the receiving instrument itself will depend, in the first place, upon (1) the kind of aerial you can erect, and (2) the distance of the nearest broadcasting station. It will also depend, of course, upon whether you wish to hear signals through an ordinary pair of head telephones or through a loud speaker. These are factors which will have to be considered carefully in each case. One house, for instance, which is situated at a distance of 50 miles from a broadcasting station, might provide excellent facilities for erecting a good aerial, whilst another house, at a distance of 10 miles from the broadcasting

station, might not allow of any kind of outside aerial. It is probable that the same type of receiving instrument would be required under these different circumstances, the factors of *distance from the broadcasting station* and *quality of aerial* balancing each other, as it were. In the latter case an indoor frame aerial would be employed, the efficiency of which is never equal to that of a good outdoor aerial. An indoor aerial, generally a frame with several turns of wire, requires at least a two valve set.

When a wireless wave strikes a receiving aerial it sets up small electrical vibrations in the latter, and it is the first task of any receiving apparatus to convert these electrical vibrations into sound vibrations. The sound vibrations so produced are an exact reproduction of the voice at the transmitting station. Certain crystals are capable of performing this important operation, but it can be performed much more efficiently by a "thermionic valve"—an instrument which was specially designed for the purpose. A valve, moreover, can be utilised to perform an additional function of *amplifying*, or strengthening, the received signals. In fact, it is largely due to the amplifying powers of the modern valve that such long distances can be obtained with wireless telephony to-day.

When used in this capacity, a valve can be made to amplify either the electrical vibrations set up in the first instance by the arrival of a wireless wave, or the sound vibrations which are obtained by the non-amplifying valve or crystal in the manner referred to above. The operation of converting the electrical vibrations into sound vibrations is usually known as "rectification." A familiar combination is as follows: one *amplifying* valve is used for increasing the strength of the received electrical vibrations, a second *rectifying* valve is used for converting these into sound vibrations, and another *amplifying* valve increases the sound vibrations before these are employed to actuate the telephones or loud speaker.

The crystal, it must be remembered, can only *rectify*; it has no amplifying powers. A number of amplifying valves may, however, be used in conjunction with a crystal, which carries out the rectifying process. In other words, whilst a crystal can only be used for rectifying, a valve can be made to function either as a rectifier or amplifier. Although, theoretically, any number of valves could be used to amplify successively,

it is customary in practice to restrict the number of amplifying valves to five or six.

The broadcast programmes can, of course, be received on a crystal alone, provided the latter is connected to a good outdoor aerial within a radius of about 10 miles. At this distance it will be possible to hear quite satisfactory signals in a pair of head telephones. Unless the receiving station were situated "next door" to the broadcast station, however, it would be useless to attempt to operate a loud speaker on a crystal equipment. With a single valve receiver, the maximum distance at which satisfactory telephone signals can be heard is about 40-50 miles; at shorter distances, of course, signals will be correspondingly louder. Only at very short distances, however, can a loud speaker be used to advantage with a single valve.

A two-valve receiver gives good strong signals at 30 miles range, and signals can still be heard in the telephones up to 60-70 miles. A loud speaker might be operated with good results at about 10-15 miles. With a crystal or valve rectifier and two amplifying valves, considerable improvement in the strength of signals can be effected. With such a combination, the signals emitted from a loud speaker should be heard throughout a large room, at a distance of about 25 miles. If three, or four, amplifying valves are used, this distance will be increased to about 40 and 60 miles respectively.

These distances, of course, will vary a good deal, depending upon the quality of the aerial used in each case, and also upon the degree of skill with which the instruments are operated. Although broadcast receivers are made as simple and compact as possible, there are certain sources of trouble against which it is impossible for the manufacturers to contend. The electric batteries, for instance, must be kept up to scratch; the earth connection must be a good one; terminals must be kept clean, etc. If these matters are attended to carefully, the distances given above may be considerably increased. If the receiver is not given proper attention, on the other hand—anything may happen!

The cost of these instruments also varies a good deal. An average price for a complete crystal equipment is £4 10s. od. A single valve receiver costs slightly more. Two, three, and four valve receivers are advertised at an average price of between £10 and £25 complete. *Receivers de luxe*, of course, cost anything up to 100 guineas.

Wireless Operators and Their Careers

By "TRAFFIC MANAGER."

This is the first of a series by the traffic manager of a very large wireless company. The advancement of the operator in his career lies largely in the hands of the traffic manager, so that the advice of one of them may be considered sound.

DURING the ten years which succeeded the adoption of Wireless on ships of the Mercantile Marine, operating was considered by those who took any interest in the matter, to offer nothing more than temporary or cul-de-sac employment. This fact was fully appreciated within the service, and few of the men who became qualified for appointment suffered any disillusionment on the matter when taking up their duties. As in all things, there were, however, compensating factors, and these were sufficient to induce those fixed with the healthiest form of ambition to don the then familiar uniform. Not only were the prospects nil, but the pay poor—up to the middle of 1911 a seagoing operator started at five shillings a week, and if satisfactory his salary was raised to fifteen shillings a week after one month's service.

At that time only the large passenger ships carried installations, and as the operator lived on board as a first class passenger, he was always assured of the best in the way of creature comforts, and an opportunity of meeting the world's most interesting people. To use a hackneyed phrase, Wireless was in its infancy—or rather its babyhood, and the most interesting form of recreation to be indulged in by passengers during their period of enforced idleness on board was an intimate study of this newly applied science. The Operator was called upon to instruct members of all the professions and businesses, thus providing him with an opportunity of acquiring a useful fund of information concerning the opportunities and prospects in the many countries to which he journeyed.

His employment was not confined to any particular line of steamers, so that in the course of two or three years he could visit all the interesting and important parts of the world. His duties left him absolutely free in port, thus allowing him time to see all the sights and places worth visiting. His work was interesting, and he took a pride in it. He was subjected to little or no supervision, but he nevertheless did everything possible to increase the efficiency

of his service and to establish a high order of opinion among those with whom he came into contact. As a rule, within a few years he made up his mind as to the most interesting and lucrative form of profession and settled down to life ashore. This was the first phase.

The second came with the increased demand for Wireless service. A severe shortage of operators was experienced, with the result that men without previous telegraphic experience were recruited from all over the country, trained hurriedly, and sent off to sea. Apparatus used on board by this time was robust and fool proof, required practically no technical knowledge on the part of the operator, and did not lend itself to adjustment for improved working beyond the recognised standard. When operators arrived in home ports, they were generally implored to sail again the same day on a different boat; but there was no time to examine their apparatus or their voyage records. Shipping Companies came under the terms of legislation in the matter of providing Wireless Apparatus and service, but, knowing little or nothing of the subject, were glad to hand over their responsibilities to their Wireless Contractors.

It was, therefore, impossible to distinguish between the men of talent, the mediocre, and the slackers, except in extreme cases, a condition of affairs that offered no inducement for hard work and a display of initiative. The fact that the established traditions of the service were well maintained does no small amount of credit to the men themselves, but due to no fault of theirs, little progress was made in the matter of efficiency.

The third phase—the one we are immediately concerned with—commenced when the country was settling down to business after the war. Wireless became a matter of competition, with the inevitable result that Shipowners were encouraged to take an interest in the service on board their steamers, and to consider the possibilities of utilising up-to-date apparatus to assist in matters of Navigation. The Operator, instead of being merely a pawn on the board, then

assumed the importance of a leading piece, and for a very good reason.

Whereas, previously, the robust and fool-proof apparatus gave a daylight range of approximately 300 miles, newly designed sets of similar rating increased this range to something above 1,000 miles. The new sets, however, required much more careful handling, and a higher degree of technical knowledge on the part of the Operator. The ranges obtainable depended more on critical adjustments which could only be made by the men working them at sea. No matter how efficiently the apparatus was designed or what results were possible when intelligently handled, if placed in charge of an incompetent operator it lost all its advantages over its predecessors.

Wireless Companies competing with each other on the clear cut issue of efficiency were, therefore, to a large extent, dependent on their operators, and it became necessary for them to organise the strictest form of selection and supervision, and to promote interest on the part of existing operators and an inducement for recruits of better training, by removing the stigma of cul-de-sac, and bridging the gulf between Wireless Operating and Wireless engineering.

In these days the better operators get the better ships; the operators who give the best service become real assets of their Company and are encouraged to qualify for remunerative Wireless employment ashore. One of the most important duties of officials who supervise the operators is, therefore, to familiarise themselves with the ability and progress of each individual man, to study the work from every possible angle, and to select operators for promotion, not from the point of view of seniority but of proved character and ability.

It is surprising how many men there are at sea who possess undoubted qualifications, show evidence of keenness and ambition, conduct themselves properly, and yet fail to rise above their fellows through neglect of essential detail which, though seemingly unimportant in their present occupation, assumes great importance at a more advanced stage. It is the writer's intention to outline in a series of subsequent articles in these pages, the manner in which an operator's work and conduct is judged, and to offer for what they are worth, his suggestions on the best methods for conducting the work of a ship station.

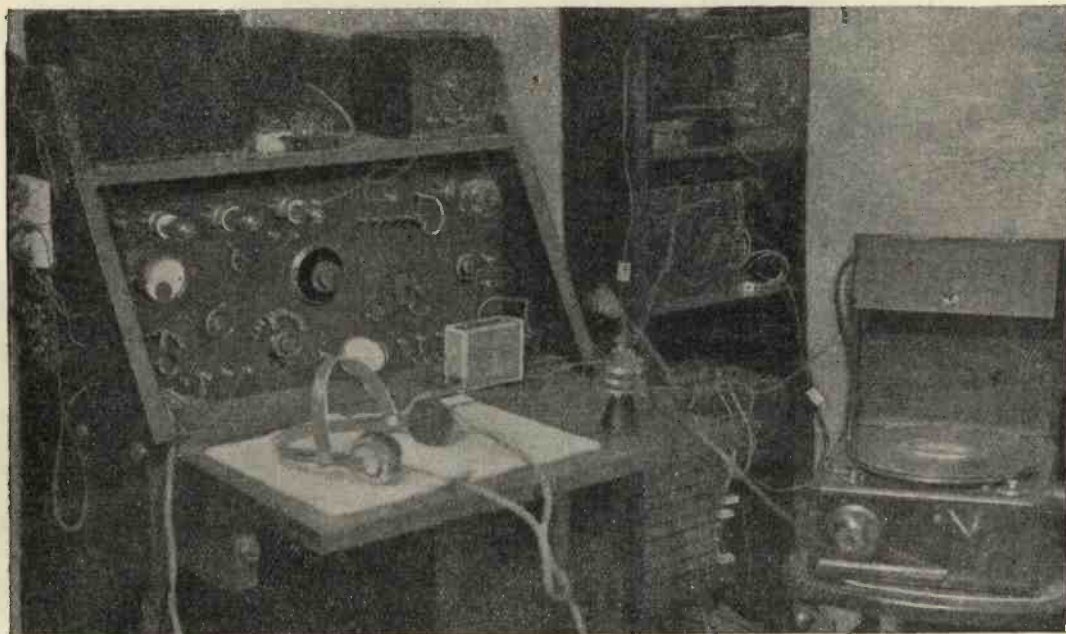

Station 2 X B belonging to A. T. Croucher.

RECENT ADDITIONS TO OUR LIST OF EXPERIMENTAL CALL-SIGNS

These additions, together with a further list which will appear in our next issue, should be added to our "WIRELESS DIRECTORY," thus forming a complete and reliable list of commercial and amateur call-signs.

CALL.	NAME OF OWNER.	ADDRESS.
2 AB	CAPT. H. DE A. DONNISTHORPE ..	London.
2 AK	R. M. RADIO LTD.	Townsend Mills, Worcester.
2 AM	MARLBOROUGH COLLEGE, O.T.C. ..	
2 AQ	MR. DAVIS	Thornton Heath, S.W.
2 AZ	WILLIAM LE QUEUX	
2 BM	J. H. A. WHITEHOUSE	Brighton, Cheshire.
2 BN	L.N.W.R.	Crewe Station.
2 BQ	L.N.W.R.	Euston Station.
2 BS	MARCONI STATION	Chelmsford.
2 CA	J. H. REYNER	69, Station Road, Chingford.
2 CB	W. E. COOKE	29, Empress Ave., South Chingford.
2 CH	SCIENCE SOCIETY	Oundle, Northants.
2 CM	W. D. B. HYDE	92, Littledale Road, Egremont, Cheshire.
2 CP	MR. ELMER	Gernham House, Birchington, Kent.
2 CX	A. L. ROCKHAM	114, Beauchamp Road, Upper Norwood, S.E.
DV	H. C. WOODALL	Bramham, Cheshire.
2 DX	W. K. ALFORD	Rosedene, Camberwell, Surrey.
2 DY	F. HAYNES	157, Phillips Lane, N. 15.
2 DZ	F. HAYNES	26, Avenue Road, N. 15.
2 FC	A. J. ROLFE	Riverside Bungalow, Weybridge.
2 FJ	J. FRY	22, Thirsk Road, Lavender Hill, S.W.11.
2 FM	V. CORRELLI	41a, Grove Road, Eastbourne.
2 FN	L. M. BAKER	Ruddington, Notts.
2 FT	EDINBURGH AND DISTRICT WIRELESS SOCIETY	Edinburgh.
2 GA	REV. J. A. GIBSON	18, Daniel Street, Bath.
2 GD	BIRMINGHAM WIRELESS SOCIETY ..	Birmingham.
2 GJ		Sheffield.
2 GR	F. FORSYTH	Ashington.
2 GS	F. FORSYTH	Ashington.
2 GT	G. IRVINE	12, Treborth Street, Liverpool.
2 HB	L. H. LOMAS	Highfield, Somerseate, Nr. Manchester.
2 HG	T. BOUTLAND (SENR.)	Ashington.
2 HS	G. W. HALE	36, Dagnall Park, S. Norwood, S.E.
2 IB	W. BEMROSE	Littleover Hill, Derby.
2 ID	E. S. FIRTH	Thames Ditton.
2 II	} SOUTHPORT WIRELESS SOCIETY ..	Queen's Hotel, Promenade, Southport.
2 IJ		
2 IS	} REV. H. W. DOUDNEY	St. Luke's Vicarage, Bath.
2 IT		
2 IV	L. F. WHITE	Priory Road, Bristol.
2 IY	J. BRIGGS	Corporation Street, Birmingham.

CALL	NAME OF OWNER.	ADDRESS.
2 JC	I. H. STOREY	Escowbeck, Lancaster.
2 JD	I. H. STOREY	White Cross Mills, Lancaster.
2 JJ	C. WORTH	4, Riverside Road, Egremont, Cheshire.
2 JL	G. G. BAILEY	The Beeches, Cowley, Middlesex.
2 JM	G. G. BLAKE	10, Onslow Road, Richmond.
2 JN	H. B. BURDIKIN	Bilton, Rugby.
2 JU	E. C. PEARCEY	610, Fulham Road, S.W.
2 JV	A. G. ROBBINS	Station Road, Epping.
2 JW	J. R. BARRAST	Westgate Court, Canterbury.
2 KA	BRIGHTON & HOVE RADIO SOCIETY	Buckingham Road, Brighton.
2 KK	HUTCHINSON & CO.	101, Dartmouth Road, S.E.
2 KL	F. PINKERTON	50, Peak Hill, Sydenham.
2 KN	A. B. DAY	Finchley.
2 KP	F. A. BIRD	13, Henrietta Road, Bath.
2 KQ	H. TAYLOR	The Lodge, Tottenham Wood, Nr. Wolverhampton.
2 KW	W. R. BURNE	Springfield, Sale, Cheshire.
2 LA	H. F. YARDLEY	121, Victoria Road, Leeds.
2 LB	H. F. YARDLEY	6, Blenheim Terrace, Leeds.
2 LD	J. COTTIS	4, Crondace Road, Fulham, S.W.6.
2 LF	P. HARRIS	Wilts.
2 LJ	WORCESTER CADET SIGNAL COY.	Junior Technical School, Worcester.
2 LU	W. A. APPLETON	Wembley Park.
2 MA	P. S. SAVAGE	Norwich Road, Lowestoft.
2 MC	H. B. DENT	Fleetwood Avenue, Westcliffe-on-Sea.
2 MR	R. H. REECE	62, Addison Gardens, W.14.
2 NA	H. FROST	Longwood, Barr Common, Walsall.
2 NH	O. R. C. SHERWOOD	41, Queen's Gate Gardens, S.W.
2 NI	P. H. LYNE	Dartford & District Wireless Society.
2 NJ	J. JOSEPHS	London, S.E.12.
2 NN	BRIG.-GEN. PALMER	Epping.
2 NQ	R. J. T. MORTON	14, Woodside Rd., Kingston-on-Thames.
2 NV	} H. LITTLE	15, Lodge Road, West Bromwich.
2 NW		
2 OI	C. BAIN	Newcastle.
2 OJ	E. A. HOUGHTON	52, First Avenue, Hove, Sussex.
2 OQ	D. P. BAKER	Cleveland Road, Wolverhampton.
2 OU	ILFORD RADIO SOCIETY	Ilford.
2 PF	F. FOULGER	London, S.E.14.
2 PI	LOUGHBOROUGH COLLEGE	Leicester.
2 PL	MAJOR L. N. STEPHENS, R.A.	Haddon House, Bridport.
2 PQ	G. E. MORTLEY & Co.	Nelson Road, Tunbridge Wells.
2 PW	MR. MATTHEWSON	Forest Gate.
2 QA	H. W. TAYLOR	Cambridge.
2 QI	HURST & LUCAS	Mayford Road, Balham, S.W.
2 QL	R. J. HIBBERD	Graywood School, Haslemere.
2 QP	L. C. GRANT	3, Langhorn Street, Newcastle.
2 QU	HURST & LUCAS	Lansdown Road, Blackheath.
2 QZ	H. B. COLQUHOUN	3, Eastboor Road, Blackheath.
2 RG	E. W. SCAMELL	Birmingham.
2 RK	A. E. BLACKHALL	7, Maple Road, Surbiton.
2 RS	T. HESKETH	42, Castle Hill Avenue, Folkestone.
2 RT	NORTH-EASTERN INSTRUMENT CO.	Low Fell, Gateshead.
2 RU	NORTH-EASTERN INSTRUMENT CO.	Nr. Newcastle-on-Tyne.



The above map gives most of the European Wireless Stations whose signals may be heard in Great Britain. Some of the call-signs have been reproduced by courtesy of the French journal "Radioélectricité."

A much larger reproduction of this map, suitable for fixing to the wall, will be presented with every copy of next month's "MODERN WIRELESS."

Some Constructional Notes

A Low-Frequency Amplifying Panel.

Those readers who are already in possession of either a crystal or single-valve receiving set and desire to obtain greater signal strength, will find an amplifying "unit" or panel, constructed in accordance with the following particulars, extremely useful. The arrangement shown in the diagram comprises an ebonite panel fitted with eight terminals, two marked "Input," two marked "Output," and two for each of the batteries, H.T. and L.T., together with valve socket, filament rheostat, step-up transformer and fixed condenser.

If a somewhat cheaper style of construction is preferred, a wooden panel may be substituted for the ebonite. In this case the standard form of valve holder (flanged pattern, to be inserted from below) may be used, but it will be desirable to either bush the holes for input, output, and H.T. battery terminals with ebonite or to drill clear holes and fit the terminals themselves upon strips of ebonite. For the sake of uniformity the dimensions of the panel should be made to correspond with an existing valve panel, but if it is to be used in conjunction with a crystal or other complete set a convenient size is $6\frac{1}{2}$ ins. by $4\frac{1}{2}$ ins.

The filament rheostat may either be purchased complete or made up by winding about 9 feet of No. 21 SWG. Nichrome resistance wire upon a lead-pencil and securing around a fibre disc $2\frac{1}{2}$ ins. in diameter. The disc should, of course, be grooved to form a seating for the resistance wire and a rotating arm fitted to make sliding contact upon the turns.

The condenser across the primary of the transformer may consist of eight pieces of tinfoil, each $1\frac{1}{4}$ ins. by 1 inch, arranged alternately and separated by mica of good quality, about $\frac{1}{200}$ of an inch thick, leaving a clear margin of $\frac{1}{8}$ inch round three sides of each foil and about $\frac{1}{4}$ inch of foil projecting (four down one end and

four down the other) to be bent over the mica when all assembled and secured by means of a strip of soft brass squeezed down with a pair of pliers, to form a kind of clip. Soldered connections are subsequently to be made to these brass "clips." If it is desired to buy a condenser, a Dubilier, capacity .001 mfd is very suitable.

One of the usual "interval" transformers, readily obtainable from our advertisers, and connected so as to give a "step-up" effect, is quite suitable for use with this type of amplifying panel. The method of connecting up the assembled components is clearly shown in the diagram, all connecting wires being of course, beneath the panel itself. The whole may be mounted upon a shallow box or merely upon two "battens" as indicated by the dotted lines. In use, the input terminals are to be connected to the telephone

terminals on the existing set whilst the 'phones themselves are transferred to the two terminals marked "Output."

A Vernier Condenser.

A very useful little piece of apparatus is a vernier condenser. It is practically essential to success when using a variable condenser of large capacity. There are, as with other kinds of apparatus, various types of vernier condensers. Perhaps the simplest to make, and incidentally the cheapest, is one constructed from test-tubes, which can be obtained from any chemist for about two pence each.



Fig. 2. A Simply made Vernier Condenser.

Fig. 2 shows the general arrangement. The condenser consists of a test-tube, about 3 ins. long and $\frac{1}{8}$ ins. diameter, about which is wrapped some tinfoil, secured with shellac, and

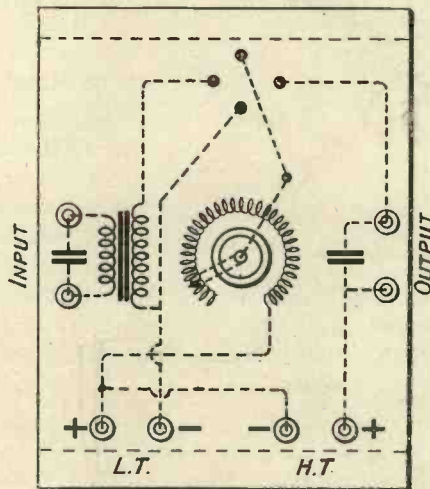

Fig. 1. Connections of the L.F. Panel.

a smaller one $3\frac{1}{4}$ ins. long and $\frac{1}{2}$ in. diameter, also having tinfoil secured around the outside. A handle consisting of a length of glass rod, 8 ins. long, is attached to the smaller tube, by filling the tube with paraffin wax, inserting the rod, and holding it in position in the centre of the test tube until the wax is set. The base

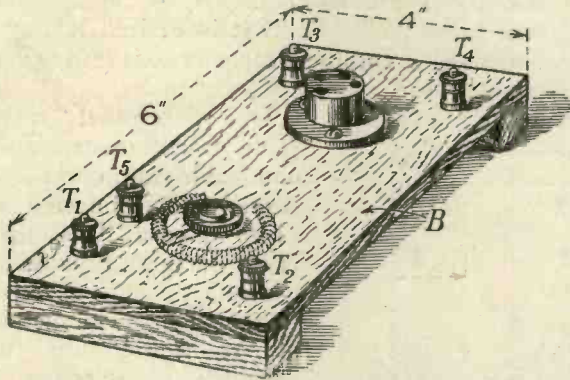

Fig. 3. Showing dimensions of the valve panel.

can be made from old, well-seasoned oak, if it is well dried in an oven and baked in shellac. Its insulating efficiency is then practically equal to that of ebonite. A convenient size is about 8 ins. \times 2 ins. \times $\frac{1}{4}$ in.

The next consideration is the bracket for supporting the glass rod. This can be made from brass, say, $\frac{1}{2}$ in. \times $\frac{1}{16}$ in. \times $2\frac{1}{4}$ ins., being bent up at right angles at about $\frac{5}{8}$ in. from each end. A hole should be drilled of such a diameter as to make a sliding fit for the glass rod in either end. The bracket is secured to the base by two small screws or nails. When fixing the larger test tube to the base it is important that the centre of it should line up with the centre of the two holes in the bracket. This can be arranged by having a small block of suitable thickness. A good method of securing the test tube to the base is to strap it down with two thin metal straps, as illustrated in the diagram. Between the strap and the glass a piece of

velvet or similar material should be inserted in order to obtain a firm hold on the glass. The straps can then be nailed or screwed to the base, provided the smaller test tube is in position. The leads should be twisted very tightly around the tinfoil on the tube, and slightly soldered in order to obtain good contact. They can then be taken to terminals on the base. The lead attached to the movable tube should preferably be flexible, as otherwise the continual bending and unbending would cause ordinary copper wire to break after it had been in use a short time.

R. E. LEWONSKI.

The Construction of a Valve Panel.

A valve panel which may be made for about $\frac{5}{6}$ is shown in the accompanying sketches. An ebonite or wooden base B has mounted on it four terminals, T1, T2, T3, and T4, a valve holder which may be purchased for about $\frac{1}{6}$, and a rotary filament rheostat which may be purchased for about 4/-. The method of securing the valve holder and the rheostat to the base board B needs no description. The

wiring of the panel is shown in the lower figure. There is no need to mark the filament terminals positive and negative because in some circuits it is desirable to have the filament rhesotat next to the positive side of the filament accumulator.

In both diagrams an additional terminal T5 is shown and is connected to one of the filament sockets of the valve holder. This terminal may be used in certain circuits where this special connection is shown.

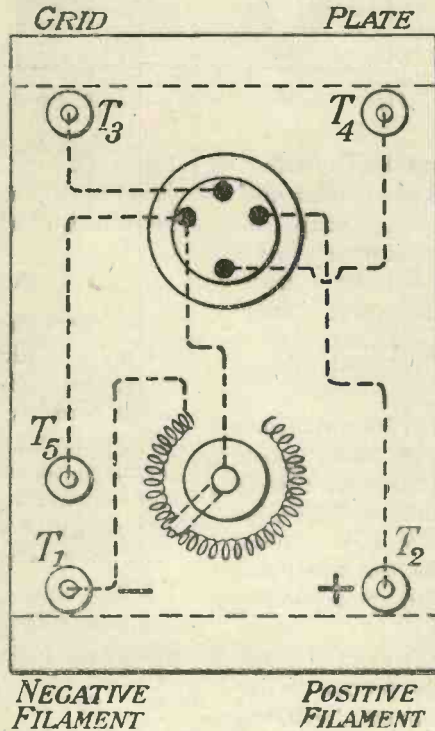

Fig. 4. Wiring diagram of the panel.

A Telephone Transformer for use with Low-Resistance Telephones.

From the point of view of cheapness, or perhaps on account of their more robust construction, many amateurs have purchased telephone receivers of low resistance. As such telephones cannot be satisfactorily used with either a crystal or a valve receiving set without

the addition of a "transformer," it is thought that constructional details of a suitable transformer will prove of service.

It consists of an iron core, $4\frac{1}{2}$ inches long by $\frac{1}{2}$ inch in diameter, made up of No. 22 SWG, soft iron wires; two end flanges, $1\frac{1}{2}$ ins. square by $\frac{3}{8}$ inch thick with central hole to take the ends of the iron core; insulation over the core, two layers of Empire cloth or paraffin-waxed paper; thick-wire winding (or secondary as this is a "step-down" transformer), 1700 turns of No. 28 SWG. d.s.c. copper wire; insulation between windings, the same as that between core and first winding; fine-wire winding (or primary), 3,800 turns of No. 44 SWG, d.s.c. copper wire; outer insulation and protection to winding, two layers of Empire cloth, or similar material; and four brass terminals, arranged as shown in the diagram herewith.

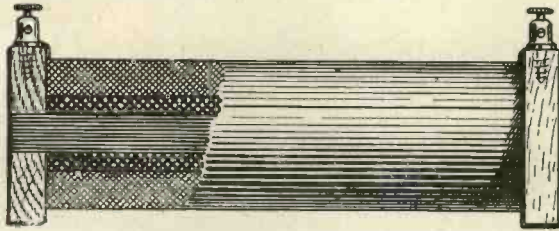

Fig. 5. Details of a telephone Transformer.

In use, the fine-wire winding is to be connected to the telephone terminals on the existing crystal or valve set whilst the low-resistance telephones are connected to the thick-wire winding of the transformer. The effect of a transformer of this description is to reduce the voltage and increase the current through the windings of the telephones.

A Simple Gridleak.

The accompanying figure shows a very simply constructed grid-leak or anode resistance. On a small piece of ebonite or wood E are fixed two terminals T1 and T2 of substantial size, say, 2 B.A., of the double type. Between the two lower nuts is tightly clamped a piece of blotting paper P, which has been thoroughly soaked in indian ink and allowed to dry. The size of this blotting paper is shown in the lower portion of the figure. A washer above and below each end of the piece of blotting paper P is arranged, so that the paper is not torn by tightening up the middle nut. Various resistances may be obtained by double or treble soakings of the blotting paper in indian ink. When an anode resistance (of about 70,000 ohms) is required the

terminals may be brought within one inch of each other, and several strips of paper on top of each other may be used.

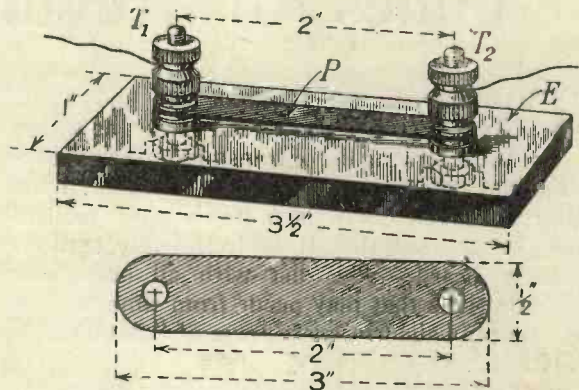

Fig. 6. Showing construction of the gridleak.

Fixing the Winding

In Fig. 7a, the wire is held by means of a loop of a tape which is bound to the cylindrical former by the following turns. A piece of thin tape about $1\frac{1}{4}$ ins. long and $\frac{3}{4}$ in. wide is folded round the free end of the wire, the tape loop then being placed on the cardboard tube, or other suitable "former," as indicated in the diagram. The successive turns of the winding are then placed above the tape loop, thus binding it firmly to the cylinder. In order that the first turn within the loop may be securely held, the ends of

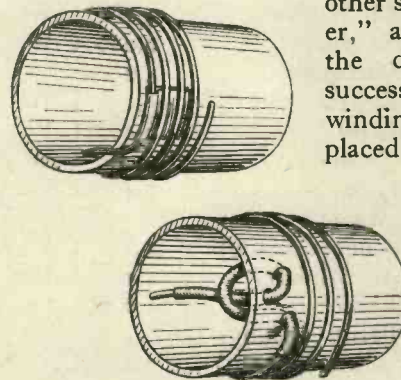

Fig. 7. (a) Fixing by tape loop. (b) Fixing by three holes.

the tape should be firmly pulled so that the first turn beds against the remainder of the winding.

The second method is shown in Fig. 7b, in which it will be noticed that three small holes, 1, 2, and 3 are shown in the end of the cylinder. The free end of the winding is passed down hole 1, up hole 2 and down hole 3. The end of the wire is then put through the loop which has been formed inside the cylinder, between holes 1 and 2, and the wire is pulled up tightly. This draws up the loop, thus firmly securing the end. As a protection to the insulation of the wire at this point, it is advisable to pass a short length of sleeving over the wire as shown in the diagram.

Times of Regular Transmissions

THE accompanying photograph shows the Radio Press Experimental station at which the following list of transmissions was compiled just before going to press. Although the list reproduced below is quite short our readers may be assured that it includes only stations actually heard. This list with all alterations and additions that may occur from time to time will be published in every issue of "MODERN WIRELESS."

TIME (G.M.T.)	CALL- SIGN.	NAME OF STATION.	WAVELENGTH.
Mid-night.	GBL	Leaffield	8,750 C.W.
0100	POZ	Nauen	12,000 C.W.
0100	ICI	Guglielmo Marconi (Coltano)	5,250 C.W.
0120	GBL	Leaffield	8,750 C.W.
0200	GKB	Northolt	6,850 C.W.
0200	GFA	Air Ministry	4,100 C.W.
0230	UA	Nantes	9,000 C.W.
0300	HB	Budapest	4,250
0315	FUA	Bizerta	5,150 C.W.
0330	FL	Paris	6,500 C.W.
0400	UA	Nantes	9,000 C.W.
0430	FL	Paris	7,400 C.W.
0550	ICI	Guglielmo Marconi (Coltano)	5,250 C.W.
0600	GFA	Air Ministry	4,100 C.W.
0600	IDO	Rome	11,000 C.W.
0635	LP	Berlin (Königswusterhausen)	5,250 C.W.
0650	LP	Berlin (Königswusterhausen)	5,250 C.W.
0700	POZ	Nauen	—
0700	FL	Paris	3,200 C.W.
0715	FL	Paris	6,500 C.W.
0730	UA	Nantes	9,000 C.W.
0735	GFA	Air Ministry	1,680 C.W.
0740	SAJ	Karlsborg	4,300 C.W.
0750	BUC	Bucharest	7,500 C.W.
0800	EAA	Aranjuez	6,700 C.W.
0800	GFA	Air Ministry	4,100 C.W.
0835	GFA	Air Ministry	1,680 C.W.
0840	LP	Berlin (Königswusterhausen)	5,250 C.W.
0845	CNM	—	5,000 C.W.
0850	GFA	Air Ministry	4,100 C.W.
0850	LP	Berlin (Königswusterhausen)	5,250 C.W.

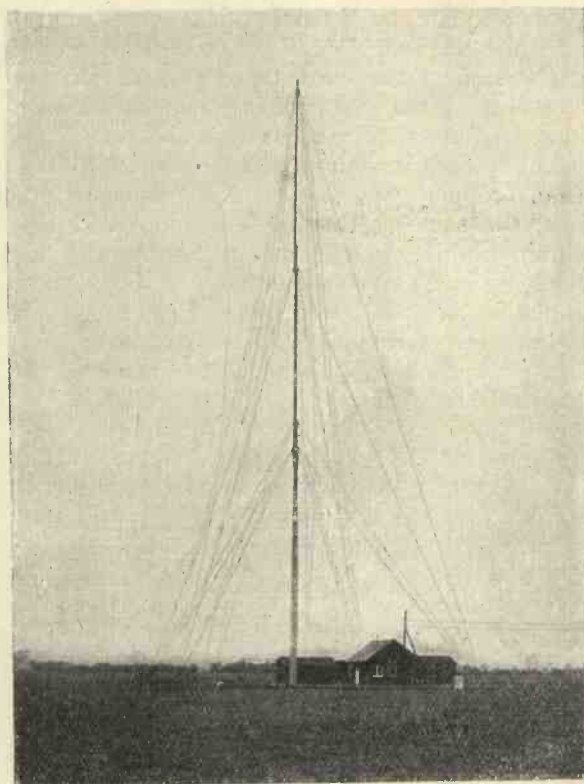

TIME (G.M.T.)	CALL- SIGN	NAME OF STATION.	WAVELENGTH.
0855	STB	Soesterburg	1,680 C.W.
0915	GFA	Air Ministry	4,100 C.W.
0925	FL	Paris	2,600 Spark.
0928	ZM	Le Bourget	1,680 C.W.
0930	IDO	Rome	11,000 C.W.
0935	GFA	Air Ministry	1,680 C.W.
1000	FL	Paris	2,600 Spark.
1003	FL	Paris	3,200 C.W.
1028	ZM	Le Bourget	1,680 C.W.
1035	FL	Paris	2,600 Spark.
1035	GFA	Air Ministry	1,680 C.W.
1044	FL	Paris	2,600 Spark.
1050	ZM	Le Bourget	1,680 C.W.
1115	PCH	Scheveningen	1,800 Spark.
1128	ZM	Le Bourget	1,680 C.W.
1130	FL	Paris	2,600 Spark.
1135	GFA	Air Ministry	1,680 C.W.
1150	ZM	Le Bourget	1,680 C.W.
1155	POZ	Nauen	3,100 Spark.
1200	GBL	Leaffield	8,500 C.W.

TIME (G.M.T.)	CALL- SIGN.	NAME OF STATION.	WAVELENGTH.
1200	ICI	Guglielmo Marconi (Coltano)	5,900 C.W.
1228	ZM	Le Bourget	1,680 C.W.
1230	UA	Nantes	3,400 Spark.
1235	GFA	Air Ministry	1,680 C.W.
1306	AN	Nimes	1,680 C.W.
1328	ZM	Le Bourget	1,680 C.W.
1335	GFA	Air Ministry	1,680 C.W.
1400	GFA	Air Ministry	4,100 C.W.
1400	GNF	North Foreland	600 Spark.
1415	UA	Nantes	9,500 C.W.
1425	OPO	Brussels	1,680 C.W.
1428	ZM	Le Bourget	1,680 C.W.
1435	GFA	Air Ministry	1,680 C.W.
1435	FL	Paris	6,500 C.W.
1500	FL	Paris	7,300 C.W.
1505	STB	Soesterburg	1,680 C.W.
1525	OPO	Brussels	1,680 C.W.
1528	ZM	Le Bourget	1,680 C.W.
1535	GFA	Air Ministry	1,680 C.W.
1625	OPO	Brussels	1,680 C.W.
1628	ZM	Le Bourget	1,680 C.W.
1635	GFA	Air Ministry	1,680 C.W.
1800	POZ	Nauen	6,500 C.W.
1800	FL	Paris	6,800 C.W.
1830	POZ	Nauen	9,000 C.W.
1830	STB	Soesterburg	1,680 C.W.
1900	OUI	Hanover	9,500 C.W.
1900	GFA	Air Ministry	4,100 C.W.
1945	CNM	—	5,000 C.W.
2000	GBL	Leaffield	8,750 C.W.
2000	SAJ	Karlsborg	2,500 Spark.
2000	EGC	Madrid	1,600 Spark.
2030	EGC	Madrid	2,000 Spark.
2045	IDO	Rome	11,000 C.W.
2200	FL	Paris	2,600 Spark.
2230	UA	Nantes	9,500 C.W.
2235	FL	Paris	2,600 Spark.
2244	FL	Paris	2,600 Spark.

TIME (G.M.T.)	CALL- SIGN.	NAME OF STATION.	WAVELENGTH.
2300	IDO	Rome	11,000 C.W.
2315	PCH	Scheveningen	1,800 Spark
2330	POZ	Nauen	12,600 C.W.

Operating almost continuously.

FL	Paris	8,000 C.W.
GB	Glace Bay	7,850 C.W.
GBL	Leaffield	8,750 C.W.
GKU	Devizes	2,100 C.W.
GLA	Ongar	2,900 C.W.
GLB	Ongar	3,800 C.W.
GLO	Ongar	4,350 C.W.
GSW	Stonehaven	4,600 C.W.
IDO	Rome	11,000 C.W.
LCM	Stavanger	12,000 C.W.
MUU	Carnarvon	14,000 C.W.
OUI	Hanover	14,500 C.W.
POZ	Nauen	12,600-C.W.
UFT	Saint Assises	15,000-C.W.
WGG	Tuckerton	16,100 C.W.
WII	New Brunswick	13,600 C.W.
WQK	Long Island	16,460 C.W.
WQL	Long Island	19,200 C.W.
WSO	Marion	11,500 C.W.

BRITISH COAST STATIONS WORKING CONTINUOUSLY ON 600 METRES.

GCA Tobermory, GCB Lochboisdale, GCC Cullercoats, GCS Caister, GKR Wick, GLD Land's End, GLV Seaforth, GNF North Foreland, GNI Niton, GPQ Parkeston Quay, GRL Fishguard, GXO Crookhaven.

CONTINENTAL COAST STATIONS CONTINUOUSLY HEARD ON 600 METRES.

FFB Boulogne, FFH Havre, FFS St. Maries, FFU Ushant, OST Ostend, PCH Scheveningen.

THE RADIO PRESS HANDBOOK AND DIARY.

THE RADIO PRESS WIRELESS HANDBOOK AND DIARY FOR 1923 HAS JUST BEEN PUBLISHED. IN ADDITION TO A CHARLES LETT'S DIARY AND 30 PAGES OF GENERAL INFORMATION, IT CONTAINS 40 PAGES OF WIRELESS DATA, INCLUDING CIRCUIT DIAGRAMS, FORMULÆ, TABLES. VALUES OF RESISTANCES AND CAPACITIES, DEFINITIONS, CALL SIGNS, AND MANY GENERAL NOTES.



The above photograph specially taken for "Modern Wireless," shows the actual apparatus used by J. H. D. Ridley in the reception of WJZ, the Newark broadcasting station. Only two stages of radio frequency amplification were employed.

How I Heard the American Concert

By J. H. D. RIDLEY.

Specially written for "Modern Wireless." A short article to encourage other experimenters.

THE experience of hearing and enjoying a concert "broadcasted" from a distance of 3,700 miles, is, I think, both unique and extraordinary. It would seem incredible, but for the certainty of the origin, i.e., WJZ (The Newark Radio Station). From a wireless point of view the conditions were ideal, a sharp frost and total absence of atmospherics. The primary object of listening-in was to test out my apparatus for the forthcoming American tests.

On Nov. 26th I commenced listening at 12.10 a.m., and until 1 a.m. was endeavouring to receive Morse signals on 200 metres from America, but without success. With such ideal weather conditions and a certain amount of good luck it seemed possible to receive one of the many Broadcasting Stations. I, therefore, moved up to 325 metres, and had no sooner adjusted the phones when a telephony carrier wave was heard, and with one or two adjustments a piano-forte solo became audible. The music was weak but perfectly clear. As only a Burndept 111 receiver was being used, it may, I think, be considered a record in long distance telephony.

To get the music louder, I added another stage of high-frequency amplification. With this I had no difficulty

in hearing and understanding practically the whole transmission. I clearly heard the announcer saying "The next item on the programme will be a Chopin prelude played on the piano and violin." Announcements and items followed in quick succession, also the message "That at 3 p.m. on Sunday afternoon there would be something worth listening to." After this followed two Columbia dance records and then "This is the Radio Corporation of America's Westinghouse Station, WJZ signing off. Good night." The time was then 3.31 a.m. I had listened to an American Broadcast Concert for 2½ hours.

Reverting then to 200 metres, during the next two hours, I succeeded in receiving no less than nine American amateur stations, the most distant one being in Chicago (4,652 miles).

The apparatus used, being as above mentioned, a Burndept 111 receiver, standard in every respect, with an additional high-frequency valve; tuning was effected with Burndept short wave coils in a tuned non-oscillating circuit. The aerial is a single wire 180 feet long, 37 feet high, situated at my home address, Woodside Green, South Norwood.

PATENTS OF THE MONTH

186,469. Colebrooke, A. H. S., and Williams, W. A.—A method of renewing filaments in valves, in which an aperture is made in the bulb at the usual sealing point and opened out sufficiently to permit manipulation. The new filament is introduced into the bulb by means of a suitably shaped glass tube inserted through the aperture, the manipulation within the bulb being assisted by specially shaped tongs. (July 21st, 1921.)

186,771. Tingey, W. R. H.—Multilayer inductance coil in which individual turns in each layer are spaced from adjacent turns, layers also being spaced from each other by spacing strips of insulating material. (August 11th, 1921.) (Cognate Application, 3534/22.)

185,384. British Thomson-Houston Co., Ltd.—Thermionic valves in which an electrode is frictionally and resiliently supported concentrically within the bulb, the supporting means consisting of springs in the annular space between the electrode and the bulb. (August 29th, 1921.)

186,956. Western Electric Co., Ltd. (Western Electric Co. Inc.)—A system for duplex wireless telephony in which oscillations of the local carrier-wave form beats with the received oscillations, the local receiving circuit being tuned to the supersonic beat frequency. In the actual arrangement locally generated and modulated oscillations are amplified by a thermionic valve before application to the aerial, the receiving circuit, which is tuned to the supersonic frequency, being included in the output circuit of the amplifier. (April 12th, 1920.)

161,573. Gesellschaft für Drahtlose Telegraphie.—Telephone systems using both high-frequency and low-frequency currents. (April 12, 1920.)

187,034. Colebrooke, A. H. S., and Williams, W. A.—In an electric discharge device such as a thermionic valve the filament is shrouded by an insulating sleeve so as to protect the bulb from deposits which render it opaque. By this means the bulb remains clear for a longer time and it is possible to see what is going on inside. (July 16th, 1921.)

187,055. General Electric Co., Ltd., and Campbell, N. R.—High vacua are maintained in vacuum tubes, such as incandescent lamps and thermionic valves by the introduction before pumping and sealing of a "getter," whose function is to combine with residual gases. The filament may be coated with this getter which may be phosphorus, sulphur, iodine, or arsenic. (July 28th, 1921.)

172,024. Ges. Für. Drahtlose Telegraphie.—A method of coupling a primary to a final oscillatory circuit by means of two intermediate oscillatory circuits through each of which currents can flow separately from the primary to the final circuit; the intermediate circuits being differently tuned, one as much above the frequency of the primary as the other is below that frequency. (November 25th, 1920.) (Patent of Addition not granted)

187,261. Ges. Für. Drahtlose Telegraphie, and Meissner, Dr. A.—A thermionic valve in which the filament is formed as a closely wound double thread helix with the two ends of the filament at the same end of the helix. (May 10th, 1921.)

187,363. Hecht, N. F. S.—Directional wireless transmitter, in which two or more directive aeriels are each excited by power valves, the grid circuits of which are excited by a separate valve oscillator. The aeriels are angularly disposed with respect to each other and the

power supplied to the aeriels is so varied by a potentiometer arrangement that the direction of maximum radiation of the whole system rotates. (August 9th, 1921.)

187,415. Moore, H. R. Rivers.—Drum switch for interchanging connections in wireless apparatus. (September 6th, 1921.)

187,457. Hamilton, B. H. N. H.—Method of keying in valve transmitters, in which the signalling key when depressed short-circuits an impedance or choke coil in the oscillatory circuit and also a resistance in series with the power supply. By suitable arrangement it can be arranged that the load is constant whether the key is raised or depressed. (October 28th, 1921.)

163,691. Ges. Für Drahtlose Telegraphie.—Simultaneous high and low frequency telephony on normal exchange system. (May 20th, 1920.)

187,646. Round, H. J.—The arrangement of a number of thermionic valves in parallel, an unshunted high resistance being inserted in series with the anodes to give the system a linear characteristic. (May 18th, 1921.)

163,709. Mauborgne, J. O. and Hill, G.—Coil aerial consisting of an archimedian spiral which may be used for directional reception. Receiving apparatus is connected or coupled to an antinode of potential along the coil. (May 24th, 1920.)

165,096. Huth, Ges., Dr. E. F.—Means for obtaining stable working in valve oscillators employing intermediate oscillatory circuits where the oscillations may fall into one or other of the two frequencies characteristic of the coupled circuits. By suitable back coupling one of these frequencies is suppressed by creating a phase displacement at this frequency between the grid and plate voltages. (June 18th, 1920.)

187,738. Robinson, J.—Directional wireless apparatus comprising a main coil and an auxiliary coil arranged at right angles to one another and rotatable together, combined with indicating means and means for superposing positively or negatively the effect of one coil on the other and associated with a resistance, inductance, condensers, extra aerial coil, coupling or the like means, adjustable at will, for at times equalizing the intensity or pitch of the signals for positions of the coils in which the plane of one coil is not pointing in the direction of the incoming electro-magnetic waves, while at other times not affecting the signals when the coils themselves give equal signals. (August 5th, 1921.)

187,907. Swinton J. H. Whittaker.—Means for obtaining efficient working when valve filaments are heated by alternating current by suitably timing the maximum filament temperature with the variations in anode voltage supplied by an alternating source. The invention also includes multi-limb filaments which may be heated by multiphase alternating currents in order to obtain more uniform emission. (July 20th, 1921.) (Divided Application on 177,816.)

188,082. British Thomson-Houston Co., Ltd.—Method of receiving radio signals by means of a number of aeriels widely separated. These aeriels are connected by transmission lines to a central station where they are selectively received. (August 5th, 1921.) (Cognate Application with 20942/21 and 21473/21.)

188,108. General Electric Co., Ltd., and Gossling, B. S.—Electron discharge devices. (August 23rd, 1921.)

EXPERIMENTAL LICENCES

By E. REDPATH, Associate Editor, "Modern Wireless."

Reliable information relative to the issue of licences for experimental purposes, together with advice as to the method of procedure to be adopted in applying for them.

CONSIDERABLE time has elapsed since the momentous announcement by the Postmaster General with regard to the establishment of Broadcasting Stations. After many delays, the various reasons for which do not concern us here, "broadcasting" is now an accomplished fact. Several of the transmitting stations operating under the auspices of the British Broadcasting Company are nightly delighting the fortunate possessors of receiving sets within range, and yet, to probably hundreds of amateurs the situation created by the introduction of two separate classes or types of licence, remains irritatingly obscure.

In the case of members of the general public whose especial object is the entertainment and general interest to be derived from the reception of music, speeches, news items, etc., transmitted by the above mentioned Broadcasting Stations, the obtaining of the necessary licence presents no difficulty. All that the intending "licensee" has to do is to proceed to the nearest Post Office where, for the sum of ten shillings, he (or she) will receive a special form of licence endorsed in red

APPARATUS USED UNDER THIS
LICENCE MUST BE MARKED



It was understood that an approved receiving set bearing a stamp similar to that shown above, had to be purchased first, and a receipt or voucher produced, but from enquiry at a post office counter, this is apparently unnecessary.

In the present article it is the writer's intention to make clear as far as possible the position of the amateur wireless "experimenter" in regard to the issue of EXPERIMENTAL LICENCES. At the very outset it is desirable that the wrong impression which it is believed prevails in many quarters with regard to the attitude of the Post Office authorities towards applicants for experimental licences, should be forthwith corrected. As a result of careful enquiries there remains

no doubt whatever that the claims of the genuine experimenters are carefully and even sympathetically considered.

It must not be imagined, of course, that an amateur who has bought, or intends to buy, a receiving set otherwise than from a member of the B. B. C.—i.e., a set upon which no royalty has been or will be paid; or who purchases a number of completed components, and merely assembles them into a set, and whose sole object may be fairly expressed by the one word "entertainment," will be considered eligible to hold an experimental licence.

For such as he the entertainment is primarily provided and, though he cannot entirely "call the tune" (though he may select which of several he will listen to), he must "pay the piper" like a Briton, firstly by taking out a Broadcasting Licence, half the fee for which is handed over to the British Broadcasting Company to help to pay for the entertainment and, secondly, by purchasing a receiving set stamped as mentioned above, the price of which includes a percentage for royalty, also for the providers of the entertainment. The question of the amount or percentage of royalty is not within the province of this article, and will no doubt adjust itself by the laws of supply and demand, in due course.

It will be fairly obvious at this juncture that the whole position with regard to the issue of EXPERIMENTAL LICENCES depends upon the interpretation given by the Post Office to the word EXPERIMENTER as applied to amateur wireless telegraphy and telephony. Although this has been appreciated for some time it is only very recently that the writer has completed investigations, the results of which enable him to give views which may be considered authoritative.

In order that the information contained in this article may interest and benefit the greatest possible number of readers, the general conditions governing the issue of experimental licences will be dealt with in the order in which they appear upon the official form, a copy of which appears overleaf.

EXPERIMENTS IN WIRELESS TELEGRAPHY.

N.B.—Under the Wireless Telegraphy Act, 1904, the Postmaster-General's authority is necessary before any apparatus for wireless telegraphy is installed or worked.

AUTHORITY FOR RECEIVING.—Summary of Conditions of Issue

(1) The Applicant shall produce evidence of British nationality and two written references as to character. A certificate of birth should be furnished if possible; but this will not be insisted on if the referees testify of their own knowledge that the applicant is of British nationality. The referees should be persons of British birth and of standing, not related to the applicant.

In the case of a company, society, or other body, application should be made by one of the principals. Any permit granted will be issued in his name and he will be personally responsible for the observance of its terms.

(2) The installation shall be subject to the approval of the Postmaster General and shall be open to inspection at all reasonable times by properly authorised officers of the Post Office.

(3) Secrecy of correspondence shall be observed.

(4) Applicants must satisfy the Postmaster General that they have in view some object of scientific value or general public utility and that they are competent to carry out experiments in wireless reception.

(5) The apparatus shall be used in such a manner as to cause no interference with other stations. In particular, between the hours of 5 p.m. and 11 p.m. on week days and all day Sunday, any oscillating valve or valve circuit employing magnetic or electrostatic reaction must not be directly coupled with the aerial or the aerial secondary circuit over the range of wave-lengths between 300 and 500 metres. The use of separate heterodyne circuits coupled with the aerial or the aerial secondary circuit over the range of wave-lengths between 300 and 500 metres is similarly restricted.

That is to say :—

(1) Any reactive arrangement or a separate heterodyne oscillator may be used directly coupled with the aerial or the aerial secondary circuit on all waves at all times, with the exception of the range of wave-lengths between 300 and 500 metres provided no interference is caused with other stations.

(2) For the range of wave-lengths between 300 and 500 metres—

(a) The use of reaction or a separate heterodyne oscillator as in (1) is permissible between the hours 11 p.m. and midnight and from midnight till 5 p.m., Sundays excluded.

(b) The use of reaction or a separate heterodyne oscillator directly coupled with the aerial or the aerial secondary circuit is not permissible between the hours 5 p.m. and 11 p.m. on week days and all day Sunday. If the use of reaction or a separate heterodyne oscillator is desired on these waves during these hours, the reaction or separate heterodyne oscillator must be so arranged that a valve is interposed between the aerial circuit or circuits and the circuit with which the reaction or separate heterodyne oscillator is coupled.

(6) A fee of ten shillings in respect of each experimental station is payable annually in advance so long as the licence remains in force.

The period covered by the first payment expires as follows :—

If the licence is taken out during the three months ended :

31st March—	on the	31st Dec.	in the same year.
30th June—	„	31st Mar.	in the following year
30th Se.—	„	30th June	„ „
31st Dec.—	„	30th Sept.	„ „

(7) *Aerials*.—Dimensions allowed are as follows :—combined height and length not to exceed 100 feet.

(8) *Portable Stations* (i.e., field stations).—General conditions as for fixed stations.

Use will ordinarily be authorised only within a radius of 10 miles of a fixed point.

The applicant for authority to use wireless receiving apparatus should complete the form of application forwarded herewith and return it to The Secretary, General Post Office, London, E.C.1, together with the required evidence of British nationality, &c.

The fee should not be forwarded until formal application is made for it.

Consider first the important sub-heading of the form, viz :—

N.B.—Under the Wireless Telegraphy Act, 1904, the Postmaster General's authority is necessary before any apparatus for wireless telegraphy is installed or worked.

The particular point to be observed is contained in the last three words. There is no illegality in purchasing, or making, either component parts, or a complete set, provided that such set is not "installed or worked" without authority. In other words anyone may make a receiving set *before* applying for a licence.

Conditions numbered 1, 2, and 3 (Form No. 43) are quite clear and fairly easy of compliance. Note, however, that under (1), the Secretary of a wireless society would be granted the licence in his own name and would be entirely responsible. Under (2), the "approval" is to be obtained

by submitting a brief written description of the apparatus (or proposed apparatus) together with a sketch of the proposed aerial. A *diagram* of the apparatus is not insisted upon, but it is advised that one should be made and attached to the application form to add its quota to the evidence of "competency" and general technical knowledge of the subject. The importance of seeing that such diagram is technically correct will, of course, be realised.

In connection with (3), it is of interest in passing to note that this condition is somewhat qualified by a paragraph upon the actual licence, to the effect that the "secrecy" does not extend to . . . "messages in connection with his (the licensee's) experiments received from another experimental station, time signals, musical performances and messages transmitted for general reception."

In paragraph 4—(Form No. 43)—are conditions to be complied with which might appear a serious obstacle to possibly the majority of amateurs. The interpretation of these conditions have been greatly modified by the Post Office in recent months, and it is now usually sufficient to show that the applicant has the honest intention to experiment, and not merely to “listen-in” to broadcast transmissions for the sake of amusement.

There are simply dozens of experiments which the licensee will be able to carry out at home, and without anything elaborate in the way of apparatus or instruments. A few suggestions are given below, whilst many variations of these and further experiments will readily occur.

- (a) Comparison of the efficiency of various kinds of crystal detectors.
- (b) Comparison of the efficiency and selectivity of various circuits used with crystal detectors.
- (c) Experiments relating to “double-rectification” by means of two crystal detectors.
- (d) Comparison of the efficiency, reliability, and cost of operation of “valve” and “crystal” detectors.

- (e) Comparison of the efficiency of various types of valves when used as high and low-frequency amplifiers and rectifiers.
- (f) Comparison of various receiving circuits, i.e., single circuit arrangements with solenoids, separate coils, series or parallel condensers, or variometers; compared with inductively-coupled tuners with “tuned” or “aperiodic” secondaries.
- (g) Experiments with a view to the determination of the most serviceable method of coupling, H.F. or L.F. amplifying valves to a rectifying valve or crystal.
- (h) Experiments with a view to the elimination of interference, including “static.”
- (i) Experiments with a view to the elimination of distortion of received “telephony” in the case of multi-valve sets.
- (j) Observation of “acoustics” with particular reference to telephone receivers and “sound amplifying” devices.

In the actual application form—(Form No. 43a, the contents of which are set out below) definite questions are asked. See paragraphs (2) and (4).

WIRELESS TELEGRAPHY ACT, 1904.

Application for Authority to use Receiving Apparatus.

N.B.—Under the Wireless Telegraphy Act, 1904, the Postmaster-General's Authority is necessary before any apparatus for wireless telegraphy may be installed or worked.

1. (a) Name of Applicant (with Christian names in full)
 Age..... Occupation
 Address
- (b) Is the applicant a British subject? (Evidence of British nationality and two written references as to character should be enclosed.).....
- (c) If the applicant is under 21 years of age, the following questions should be answered:—
 *Name of parent or guardian (with Christian names in full).....
 Whether British subject or not (evidence and references as under 1 (b) to be furnished).....
 Relationship (if any) to applicant.....
 Occupation
2. (a) Scientific qualifications (if any) of applicant.....
 (b) Particulars of any experience in working wireless apparatus
- (c) Particulars of any certificate of proficiency in radio-telegraphy from the Postmaster-General and service in wireless branches of Navy, Army, or Air Force.....
3. Full address* of the station or stations at which wireless apparatus would be installed
 *(In the case of portable (outdoor) stations, the proposed area of operation should be stated. This should be defined as within a radius of 10 miles of a specified point).....
4. Particulars of the nature and object of the experiments which it is desired to conduct with the apparatus.... (General statements such as “Wireless Telephony,” “Improvements in efficiency,” etc., are not sufficient.)
5. Is it desired to use the station for the reception of programmes transmitted by British Broadcasting Stations?
- †6. Description of apparatus to be used.....
- †7. Sketch of Aerial which it is desired to use (showing height and dimensions, including leading-in wires.)
- Signature of Applicant.....
 Date
- Countersignature of parent or guardian, if the applicant is a minor:—
- Date

* If the applicant is under 21 years of age, any permit granted will be issued in the name of his parent or guardian who will be personally responsible for the observance of its terms. Evidence of British nationality and references should be furnished both in respect of applicant and of his parent or guardian.

† N.B.—If more than one Station, give particulars in respect of each Station.

For all Wireless Requisites

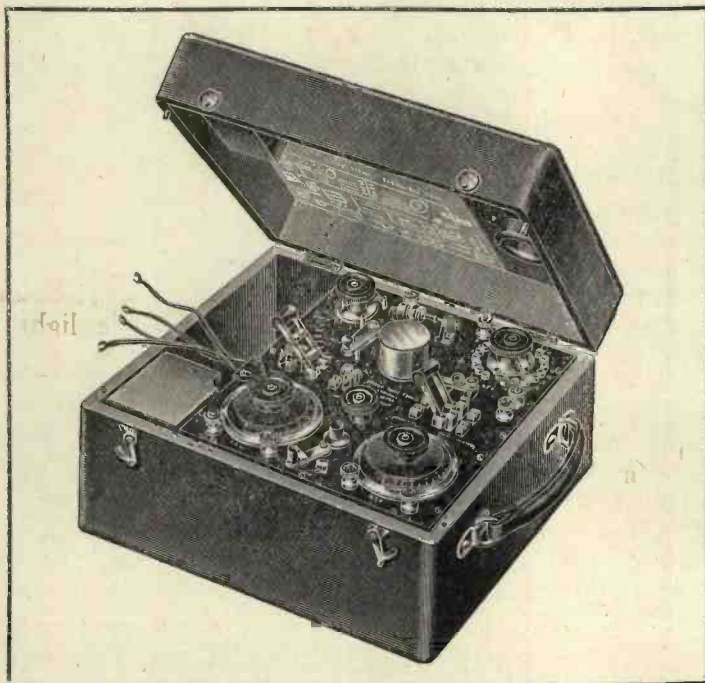

- AGENTS**
- Messrs. A. Franks, Ltd,
95/7, Deansgate, Man-
chester, and 30, Brad-
shawgate, Bolton.
 - Messrs. G. E. Beale,
Ltd., Bournemouth.
 - Messrs. Robertson and
Hogge, 29, Nicholson
Street, Edinburgh.
 - Messrs. T. Wainwright
and Sons, Ltd., 329,
Lord Street, Southport.
 - Messrs. Smith Bros.,
33/4, North Road,
Brighton.
 - Messrs. Secretam and
Mallett Ltd., 149, Low-
ther Parade, Barnes,
S.W.13.
 - Messrs. Capper Bros.,
89, Chertsey Road,
Woking.
 - Messrs. Francis Hallam
Ltd., 22, High Street,
Burton-on-Trent.
 - Messrs. Barnards, 151,
Broadhurst Gardens,
N.W.6.
 - Messrs. Alert Electrical
Co., Ltd., 202, West
End Lane, Hampstead,
N.W.6.

Special Terms to the Trade.

“RADIOMAC” Crystal Mark III

Regd. No. 237

BROADCAST SET PASSED BY P.M.G.

Range of set about 50 miles; Wave length 150 to 1200 metres, covering the entire broadcasting and shipping range. Brand new, mahogany box, complete with pair of 4000 Ohm telephones **£10 10 0**

Write for **PRICE LISTS** and particulars of our many other valve receiving sets, both for experi-menters and for those holding broadcast licenses.

We still have several towns and districts in which we have not appointed agents. Write for particulars.

LESLIE McMICHAEL LTD.

OFFICES (to which all communications should be addressed)

HASTINGS HOUSE, NORFOLK ST., STRAND, W.C.

Showrooms
179, STRAND, W.C.

Warehouse and Test Room:
PROVIDENCE PLACE, KILBURN.

Works:
SLOUGH.

Doing away with the aerial

Where there is electric light, an aerial is unnecessary. Plug a "Ducon" into an ordinary lamp holder or wall socket, connect to the wireless receiver and you will receive the broadcasting perfectly. The set is quiet, there is no noise from the mains, and the "Ducon" is perfectly safe to use, consumes no current and does not affect the electric light in any way.

The "Ducon" gives satisfactory results with all types of receivers, from crystal to multi-valve.

The **DUCON** 10%

is obtainable from all leading wireless dealers, electrical contractors and stores, or direct from the makers. *Dealers not yet stocking are invited to write for trade terms.*

Over 50,000 in Use.

The Dubilier Condenser Co., (1921) Ltd.
Ducon Works, Goldhawk Road, Shepherd's Bush, London, W.12.

Telephone: Hammersmith 1084

Telegrams: "Hisvoltcon, Phone, London"

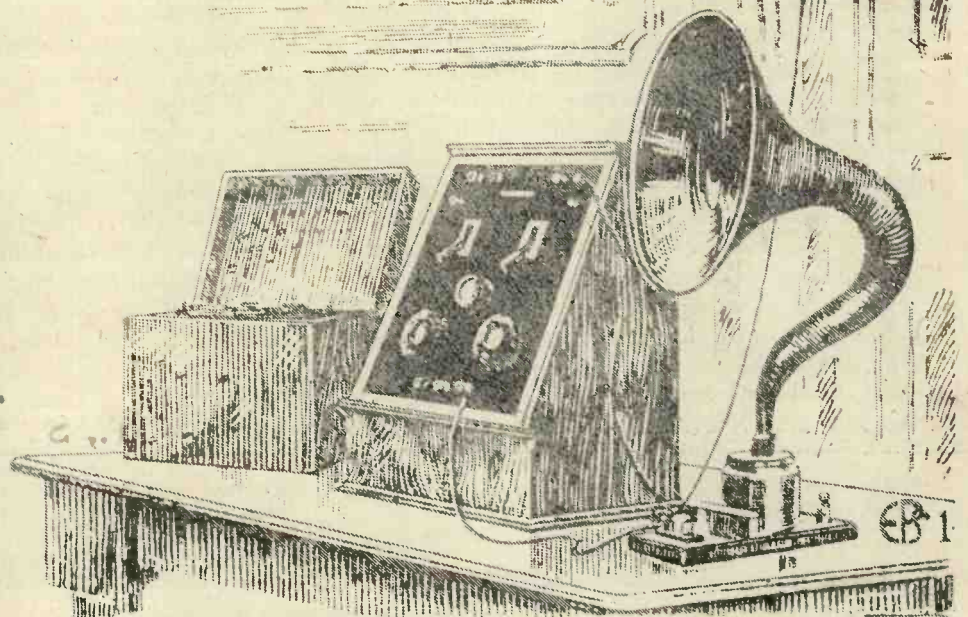
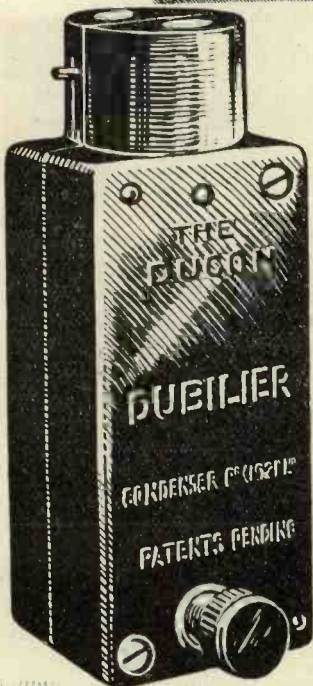

Readers interested in these announcements are requested to use the post card at end of Magazine.

Readers who are in a position to give immediate and satisfactory replies to the three questions under (2) will scarcely be in any difficulty about licences at this date. They will probably already possess them, unless their interest has waned; an unusual occurrence. The special object of this article, however, is to assist those amateurs who have had no experience in the working of wireless apparatus and who, in the ordinary way cannot obtain such experience until they have been granted a permit.

Consider firstly the acquirement of "scientific qualifications." For the purpose under discussion these may be taken to comprise "general theoretical knowledge of the subject of wireless telegraphy" and, with this view in mind, several methods of acquiring such knowledge will no doubt occur to readers, such as the reading of a few reliable text-books or hand-books; attendance at lectures or evening classes; the taking of a course of instruction, all of which might be summarised under the heading of "study."

Although a licence could probably be obtained by satisfying the P. O. under section (a), (b), or (c) of paragraph (2) on Form No. 43a, the applicant is strongly advised to add, under the remaining sections, anything which may prove of assistance.

With regard to the obtaining of "experience in working wireless apparatus" there are two courses open to the would-be experimenter. He may make a purchase of broadcasting apparatus, take out a licence accordingly and, having operated his set for a few months, or possibly a lesser period, concurrently studying the principles involved, he may put forward the fact of his possession and use of a broadcasting set as evidence of "experience."

The alternative course of procedure is to select a design of a receiving set, preferably not too complicated to commence with, and to undertake the actual construction of the set selected.

The selection and the constructional work involved will be greatly facilitated by the would-be experimenter, in addition to obtaining and reading hand-books, etc., becoming a regular subscriber to a wireless periodical devoting special attention to his needs and, if possible, joining some local wireless association where he will as a rule, receive every assistance and encouragement from the officials and members. Valuable experience could also be gained by assisting some established experimenter.

If the construction of the home set is to be put forward as evidence in the application, such set should not be merely an assembly of a number of completed and bought components. Some items, of course, must be purchased. It should be thoroughly understood, however, that once the licence is obtained, the holder is free to purchase for assembly whatever completed components he requires and would, in many cases, be following a plan of mistaken economy by attempting to make for himself items which, thanks to the enterprise of many reliable wireless firms, he could obtain ready-made, promptly, and cheaply.

After a short period of this preliminary work, or say by the time that his receiving set is completed, he should certainly be in a position to know what particular line of experiment or research appeals to him and, whatever this line may be, it can be put forward as a reply to item 4 upon Form No. 43a.

Applicants whose methods of procedure have been discussed above, should certainly send in (along with the application form) a carefully written letter explaining the extent of their activities up-to-date, and, if possible, a confirmatory letter or testimonial from someone connected with the electrical profession, upon the staff of some educational establishment (e.g., a science master), or, probably best of all, an established local amateur wireless experimenter whom the applicant has assisted in his experiments.

It remains, therefore, for each would-be experimenter to consider the question in the light of this present article; to obtain the application form by writing to the Secretary—General Post Office—London, E.C., to carefully complete same and, together with any references or testimonials available submit to the Post Office authorities for consideration.

It has recently come to the writer's knowledge that a number of applications for experimental licences have been "turned down" but, as he has had no opportunity of looking into the cases in question, he is unable to offer any suggestions regarding the probable cause of non-success.

An initial statement that, upon considering the application the authorities are unable to issue a licence, should not be taken as final. In every case a copy of the application form with replies given thereon, also of any attached papers submitted, should be retained by the applicant so that in the event of the first application being turned down, he is in a position to go over the whole ground again, scrutinising the various

The Premier Weekly Wireless Paper

Among the brilliant list of writers who have contributed to "Popular Wireless" are:—

**Sir Oliver Lodge, F.R.S.,
D.Sc., M.I.E.E.**

Dr. J. A. Fleming, F.R.S.

Dr. Lee De Forest.

Dr. Irving Langmuir.

Professor A. M. Low, D.Sc.

P. J. Risdon, F.R.S.A.

Sir William Noble, M.I.E.E.

William Le Queux, M.I.R.E.

E. Blake, A.M.I.E.E.

**John Scott-Taggart,
M.L.R.E., F.Inst.P.**

**Philip R. Coursey,
F.Inst.P., A.M.I.E.E.**

and many other famous Radio
scientists.

"POPULAR WIRELESS" will appeal to the novice and expert alike, taking the reader step by step, through the miracle of wireless. It will show you how you may enjoy all the advantages of this new science in your own home, teaching you how to make all the necessary instruments at little cost, and giving valuable hints on their upkeep and repair.

Authentic without being unduly technical "Popular Wireless" is the weekly topical paper that describes explains and freely assists all who are interested in Radio. A staff of experts has been engaged to answer FREE BY POST all wireless questions from readers. Whatever your problem "Popular Wireless" will solve it for you.

BUY A COPY TO-DAY—

and tell your newsagent to save a copy for you every week. "Popular Wireless" caters for amateur experimenters and "listeners in." It has the deservedly excellent reputation of being the brightest and most attractive wireless weekly magazine in Great Britain

ASK FOR

POPULAR **3d**
WIRELESS
Weekly



Every Friday.

OF ALL NEWSAGENTS
AND BOOKSTALLS.

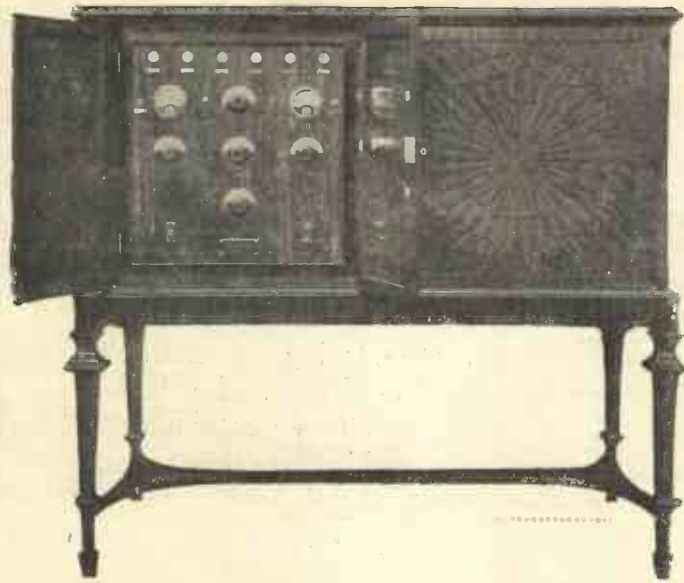

The G.R.C. Aristocrat

This is we think the finest example of expert scientific knowledge combined with fine craftsmanship and design.

Our cheapest set and smallest part is made on similar lines.

You should ask us

ANYTHING you wish to know about Wireless can be answered by the G.R.C. experts. We make what is probably the largest range of wireless equipment. At our Harlesden factory every part is made, tested, assembled, and finally tested on Aerial before being despatched. Everything any amateur may require at bottom prices, the smallest parts, the most modern improvements, are within our range. If you wish to save money and secure satisfaction and enjoyment, you should certainly get our quotations and catalogue.

The G.R.C. complete receiving sets range from an attractive Crystal Set up to the most beautiful Drawing-Room Cabinet equipment. The G.R.C. 5. Crystal Set

at £4 5s. is a most attractive and well-made set, in a mahogany case, guaranteed up to a range of 25 miles, complete with Aerial equipment and telephones. There is the G.R.C. 18, a highly sensitive single valve set: its range will include any official Broadcasting Station—an ideal set at £6 6s. Cabinet Sets include the beautiful "Country House" of Tudor design, and the "Aristocrat," as illustrated above. In these two sets expert design, simplicity of erection and inspection combined with beauty and craftsmanship, have reached the pinnacle of achievement. We invite enquiries about our guaranteed equipment, either through the post or at our London Showrooms.

THE GENERAL RADIO CO.,

Twyford Abbey Works,
Harlesden, N.W.10

London Showrooms: 105, Great Portland Street, W.1.

Wonders of Wireless Made Easy

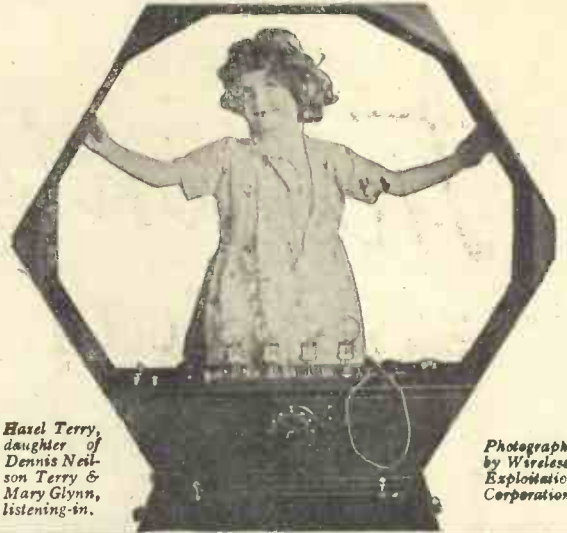

Hazel Terry,
daughter of
Dennis Neil-
son Terry &
Mary Glynn,
listening-in.

Photograph
by Wireless
Exploration
Corporation

“THE BROADCASTER,” the first British wireless monthly, owes its popularity to the way in which it simplifies the most complex radio problems.

ALL technical articles are illustrated with numerous photographs and diagrams—every point is made perfectly clear. Those who wish to get all the enjoyment they can from their sets, will find “THE BROADCASTER” useful in innumerable ways. Regular features include a readers’ question bureau and a description of a well-known amateur transmitting set.

Become a regular reader—“THE BROADCASTER” saves you time, money and worry. Give your newsagent a standing order.

Special Features of the February Issue.

A description of the best known Broadcasting Station in England.

A profusely illustrated description of a Broadcasting Station at work.

“Words With Wilfred.” Fred Kitchen’s wireless “Wee MacGregor.”

The largest number of interesting photographs in any British wireless magazine.

The Broadcaster

THE RADIOPHONE MONTHLY FOR LISTENERS - IN

FEBRUARY NUMBER JUST OUT - - ONE SHILLING

"The only magazine that has supported the Wireless-Amateur for ten years."

THE
WIRELESS WORLD
 AND
RADIO REVIEW

THE BIGGEST AND OLDEST WIRELESS WEEKLY.
Price 6d. nett. Every Thursday.

"Volumes of *The Wireless World* since the Armistice probably contain more actual constructional advice than all the British Wireless Text Books." *Vide Daily Chronicle, May 30th, 1922.*

"*The Wireless World*" was the first magazine to give constructive articles for the experimenting amateur.

Until April, 1913, the British Public had no journal devoted solely to Wireless, and the appearance of the "*Wireless World*" on the Bookstalls immediately attracted tremendous sales, which have rapidly increased, with the result that its readers are to be found in all parts of the World.

It has always been the policy of "*The Wireless World*" to look after the interests of experimenters, and largely through the publicity given to matters of importance to its readers and the Public generally, do they owe the position and facilities which they enjoy at present.

The Wireless Society of London, now known as The Radio Society of Great Britain, appointed "*The Wireless World*" as its Official Organ in 1920. Our readers are therefore kept up-to-date with the latest developments and experiments of the members of this important Association, and have the benefit of a permanent record of their work.

Specimen copy free upon application to:—

The Wireless World & Radio Review
 Dept. M.W.

12-13, Henrietta Street, Strand - - London, W.C.2.

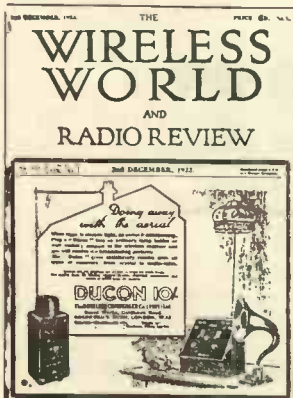

technical points involved, modifying them as indicated in the reply received from the Post Office, and seeing whether he has omitted any qualification which could help him.

If, after a second submission, the authorities do not grant him a licence, it is up to the applicant to improve his qualifications and apply again, later.

Should the applicant consider, however, that he has the qualifications as outlined in this article, but is unable to obtain the desired license, he should seek the advice of the secretary of his local wireless club. If this official is also satisfied that the applicant possesses the essential qualifications, a letter from him to that effect should accompany a new application.

In conclusion, two important points are particularly to be noted.

Firstly, this article is intended for the guidance of the genuine would-be wireless experimenter

who is having a difficulty in securing his licence or who perhaps is temporarily deterred from applying for same owing to the apparently difficult formalities to be complied with. It is hoped that the article will encourage such amateurs and that, having carefully considered his own individual circumstances, each will honestly set out to qualify; complete an application form taking especial care that all statements made therein are capable of substantiation, and in due course successfully obtain an experimental licence.

Secondly, it should be confidently kept in mind that, at present at all events, the authorities have no object whatever in restricting the activities of the genuine amateur experimenter who desires to use wireless receiving apparatus. This is surely proved by the fact that, at the present time, experimental licences are being issued at the rate of one hundred and twenty per day.

Digest of Current Radio Literature

Nature of Speech and its Interpretation.—H. FLETCHER (Franklin Institute, J.193, pp. 729—747, June, 1922.)

This paper will be of particular interest to those experimenting with means for amplifying speech without distortion. The paper describes experiments investigating the nature of distortion. A method is described for measuring quantitatively the ability of the ear to interpret the transmitted speech sounds under different conditions of distortion and loudness.

In brief, the method consists in pronouncing detached speech sounds into the transmitting end of a special telephone system and having observers write the sounds which they hear at the receiving end. The comparison of the sounds called, with those observed, shows the number and kinds of errors made.

The percentage of correctly received sounds out of the total spoken words is called the "articulation" of the system. It was found that the intensity of undistorted speech does not affect its interpretation, whether the variation is from a hundred times greater to a million times smaller than the initial speech intensity.

It is found that any apparatus, such as an amplifier, designed to reproduce speech and preserve all its characteristic qualities must transmit frequencies from 100 to above 5,000

per second with approximately the same efficiency. Although most of the energy in speech is carried by frequencies below a thousand, the essential characteristics which determine its interpretation are carried mostly by frequencies above a thousand. In ordinary conversation the terms Th, F, and V are the most difficult to hear and are responsible for half the mistakes in interpretation. The characteristics of these sounds are carried principally by the very high frequencies.

The paper is illustrated by diagrams and many tables and graphs.

The Organisation of Modern Radio Communication Systems, T. BRENO (Radioélectricité, Vol. 3, No. 10, Page 425, October, 1922.)

This is a particularly interesting article, being one of a series relating to commercial arrangements for the transmission and reception of wireless messages.

Atmospherics, their Origin and their Elimination. G. MALGORN and J. BRUN (Radio-électricité, Vol. 3, No. 10, Page 416, October, 1922).

This is one of a series of important articles on the origin and elimination of atmospheric disturbances. Different attempts to overcome the troubles experienced when receiving long waves are fully described and discussed.

WITH THE MANUFACTURERS

A New Exide Battery

Many experimenters now prefer to obtain their high voltage supply from a source other than that of a battery of dry cells. To these a new high voltage unit of secondary cells, made by the Chloride Electrical Storage Company will be of considerable interest. We reproduce a photograph of their "K.B." battery which has been specially made for wireless purposes. Each cell consists of one positive and one negative plate contained within an ordinary test tube. The plates are prevented from short circuiting by ebonite separators and the assembly is such that any cell can be quickly and thoroughly inspected at any time. The batteries, which are made in 24, 28 and 32 volt sets, are supplied either with a jelly electrolyte or in an uncharged condition for use with ordinary diluted acid. The 24 volt unit illustrated above is retailed at 25/-.

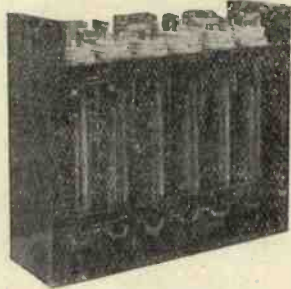

The Exide Battery.

The "Amplion Junior"

The "Amplion Junior" is the name given to a small loud speaker which has recently been put on the market by Alfred Graham & Company, an illustration of which appears on this page. The receiver is of the electro-

magnetic type. The permanent magnet is of the laminated variety and is of suitable proportions to produce a strong magnetic field which is completed through the diaphragm.

The latter is rigidly clamped to the edge of the case and is held in position by a cover plate which carries the horn. The magnetic system is fixed to a fine pitched screw which terminates in a milled headed knob outside the case. The distance between the magnets and the diaphragm is thus capable of very fine adjustments. The instrument is wound for high or low resistance working, and its moderate price should make it very popular amongst our readers.



The "Amplion Junior."

A Three Electrode Condenser

The three electrode condenser is the name given to a new type of condenser made by Autoveyors, Ltd. It comprises three sections, each section consisting of a tier of parallel plates of one-third disc area. The centre section is spindled and knobbed and permits a variation of capacity over 360°. Both side sections are spindled, geared and knobbed, permitting vernier control of extreme precision. The exact position or active area of each section is indicated by a transparent disc fixed on the centre spindle and ivory facsimile vanes fixed on the side spindles. Thus, whilst providing all the essentials of an ordinary variable condenser, it affords the added advantage of the coupling of the third electrode, which may be used with advantage in a variety of circuits.

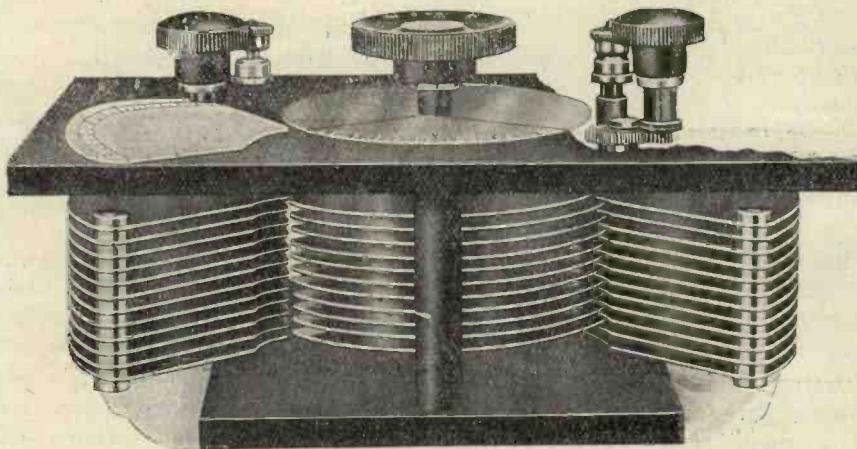

Illustrating the construction of the Three Electrode Condenser.

AUCKLAND'S

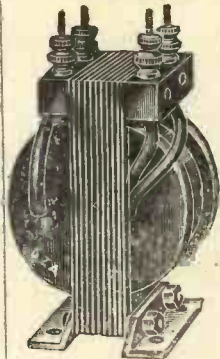

Intervalve Transformers

Most efficient cores being built up of Stalloy and in correct proportion. The bobbin is Layer Wound, each Layer being spaced. Designed to give maximum amplification.

Price **20/-** each

Delivery — stock.

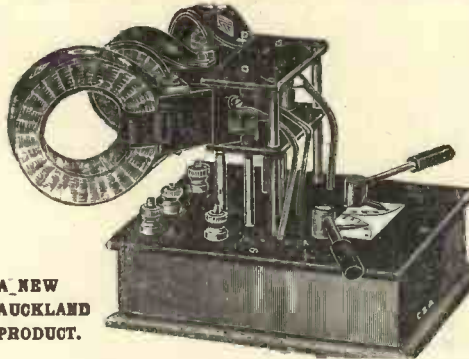

A NEW AUCKLAND PRODUCT.

3 Coil Holder with Remote Control keeping Capacity effects from body. Finish as a first-class instrument.

PRICE **22/6** EACH

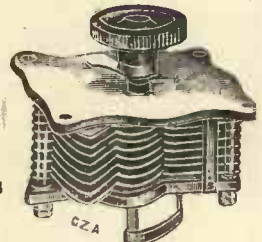

Auckland Condensers

·0002 MFD 15/- ·0005 MFD 18/-
·0003 " 18/- ·001 " 24/-

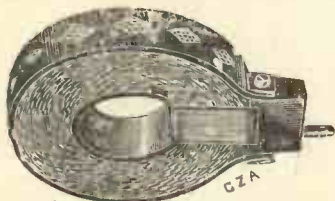

Auckland (Ingranic) Duolateral Coils.
Made under De Forest Patents.
Prices from 5/- Mounted.

Insist upon having AUCKLAND Products.
ALL AUCKLAND Valve Apparatus is duly licensed under Marconi Patents for Amateur use in Great Britain.

G. Z. AUCKLAND & SON,
LONDON
OFFICE: 395, St. John Street, London, E.C.1.

Phone: 3173 Clerkenwell. Wireless Instrument Makers. Factories: Islington, N.

COIL HOLDER.

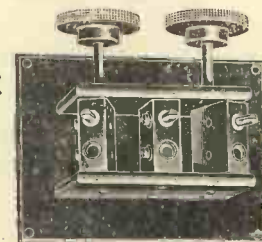

Three way, Panel Type.

PRICE **12/6**

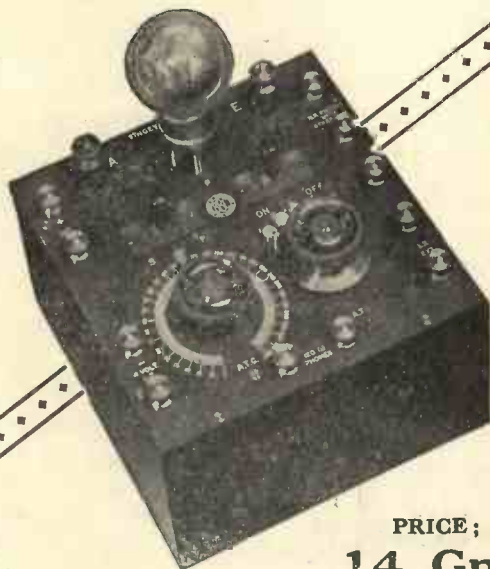

PRICE;
14 Gns.
including
Broadcasting Fee
Carriage Paid U.K.

Offices and Works:—
Phone: Hammersmith 1916.
Grams: "Tingoldar, London."

You may depend upon it—

that if the name TINGEY is on a wireless instrument, it is perfectly efficient in every detail. Here is a selection from the splendid TINGEY range:—

SINGLE VALVE BROADCAST RECEIVING SET

Wave length 300-2800 metres. Complete with all accessories, including valve, Brown's phones, high tension battery, accumulator, 100 ft. Aerial wire, insulators, lead-in tube and earth wire.

ALL TINGEY instruments bear the B.B.C. stamp.

Send for our beautifully illustrated Catalogue, containing full details of our 2, 3 and 5 valve sets to:—

Offices and Showrooms:—
92, Queen Street,
Hammersmith, London, W.6.



ON SALE EVERYWHERE

THE LEADING WEEKLY

*Fully
Illustrated
by
Helpful
Diagrams
and
Photographs*

Devoted exclusively to the interests of Wireless Amateurs; Explains the Underlying Principles; Makes the Way Plain to Beginners; Shows them How to start; What to do; What to Buy; What to Make, and How to Make It. Gives Expert Replies to Readers' Questions; no matter what the difficulty is, the Reader is helped out of it by Highly Skilled Experts; Wireless Club and Society Fixtures; and the Latest News of Wireless Developments.

The Best Paper for Wireless Amateurs

Amateur **3^{D.}
Net**
Wireless
And Electrics

Every Thursday, 3d. net

The House of Cassell
La Belle Sauvage, London, E.C.4.

A Page for the Absolute Beginner

Below will be found a very much condensed account of the principles of wireless and broadcasting. A fuller account will be found in "Wireless for All" (6d.) and "Simplified Wireless" (1/-), published by Radio Press Limited, the publishers of this journal.

HOME wireless is divided into two classes. There are those who are only interested in broadcasting and the reception of music, lectures, concerts, news items and so on, given out from the several broadcasting stations dotted about the country. There is another class which is primarily interested, although only in a non-professional manner, in the technicalities of the subject of wireless. This latter class is interested, not only in broadcasting, but in the thousands of the other kinds of signals and messages which are being sent by wireless, such as messages from transatlantic stations, from ships, from aeroplanes, etc.

Whichever class you intend to belong to you must know something about the subject. The best way of acquiring this is to buy, in the first place, the two very simple little books mentioned in the subheading to this page. You should try and get in touch with someone who has already installed a wireless receiver in your district. If possible, get in touch with a member of the local wireless society, and preferably join this Society yourself. The fees are small and no technical qualifications are necessary.

Having got some general ideas on the subject you may then ask your friend's advice as to purchasing a wireless receiver. If you are only interested in broadcasting you might, if you preferred, go straight to a wireless dealer of standing and ask his advice, telling him your needs and the amount you desire to pay for your set. If you desire to take up wireless experimenting, or to make your own wireless receiver, you should most certainly get in touch with another wireless experimenter. Your first real step will be to apply for an experimental license from the General Post Office, London. This license will cost you 10/- and the method of procedure to obtain it is described in an article in this issue.

While waiting for your license you cannot do better than make up one of the sets described in "Simplified Wireless," or in this first issue of *Modern Wireless*. You had better begin on the crystal receiver before attempting anything more ambitious. The golden rule for experimenters is to join a Wireless Society. The golden rule for the would-be broadcast receiver is to talk to an experimenter who already has a set installed. We hope that our advice will not be considered interested if we advise you to take in a good wireless periodical and to buy good authoritative books on wireless.

Having made, or bought, your set, the next thing to do is to fix up your wireless aerial, and this will only call for a little common sense and a little time in reading the aerial section of the two little books mentioned above.

A wireless transmitting station consists of special apparatus, which sets up electric currents in a length of wire slung up at as great a height as possible—usually between two masts. The currents in this *aerial*, as it is called, set up invisible wireless waves which travel in all directions. The distance these waves travel depends upon the power of the transmitting station. The waves may be received by the receiving station which consists of very much simpler apparatus, usually, and an aerial wire slung up, usually, between the house and a tree, or between two poles, or, in fact, in any other way. The receiving aerial for broadcasting and experimental work is usually about 100 feet long. When the receiving station is being operated, the wireless waves from the transmitting station are caught by the aerial wire, producing electrical currents which operate the receiving gear and cause buzzing noises, speech or music, according to the nature of the transmissions from the transmitting station. These noises come from telephone receivers, or what is known as a loud-speaker, which is somewhat similar to a gramophone horn. The telephone receivers are somewhat similar to the telephone receiver

ear-piece on the ordinary telephone. Any number of wireless receiving stations within a certain range of the transmitting station may be able to pick up the messages from that transmitting station.

It may be asked whether, as so many wireless transmitting stations are working in the world, there is not a jumble. The reason why there is not a jumble is that the transmitting stations send out different kinds of waves, and at your receiver you pick out the particular kind that you want to receive.

Wireless waves are somewhat similar to the ripples produced on the surface of a pond when a stone is thrown into it. These ripples travel outwards in all directions, as do wireless waves. The wireless waves, however, are invisible. When one person speaks to another, the speech is communicated by waves in the air—sound waves. When a wireless transmitting station transmits, somewhat similar waves are set up, but they are not heard by an ordinary person in the ordinary way, they require a special receiving apparatus to make them audible.

Different transmitting stations send out their messages with different kinds of waves. These waves differ from each other in their length; the length of a wave is the distance from the crest of one wave to the crest of the next wave. The receiving apparatus may be tuned, that is to say, adjusted, so as to pick up only the waves of a certain station. When different strings on a piano are struck different notes are sent out. Perhaps one note will be high and another low. The difference between these notes is that the sound waves, in the case of one note, differs from the sound waves produced in the case of the other note. The human ear can tell the difference between one and the other.

In the same way, a transmitting station may be arranged to send its signals on one note or on another. The wireless receiver is also able to distinguish between the different wireless waves, and it is possible so to adjust the apparatus that only the desired waves will be received, the others not being made audible at all. By giving different stations different wave-lengths to work on, it is possible to be able to pick up at a receiving station waves from hundreds of different wireless stations.

Most ordinary wireless business messages are sent in the Morse code, which consists of short and long buzzes known as dots and dashes. These are arranged in a special manner to represent different letters of the alphabet. The serious experimenter should preferably learn the Morse alphabet, but the broadcast receiver will not need to learn the Morse code at all, but if he hears buzzing noises in his receiver these will probably be due to him hearing messages being sent in Morse code. The ordinary music and speech comes through just as if one were in the same room as the artist.

Weather does not effect wireless. Wireless broadcasting is sent out from stations having a room in which the actual artistes appear. Unlike the case of the gramophone, it is not possible to pick and choose one's items. There is a set programme each evening, just as in the case of a concert.

If you do not know much about wireless, do not be alarmed. The person taking up broadcasting needs no technical knowledge. The person who intends going in for experimenting can start straight away with only a small amount of technical knowledge which he can pick up from the two books mentioned above.

Our final advice is—worry your wireless friend! If you haven't a wireless friend, make one. Wireless experimenters are decent fellows as a rule and will gladly give you advice, but don't worry them over things you can read about in booklets costing only a few pence.

BUY
RADIO PRESS
BOOKS

DIRECTORY

OF

Wireless Societies and Suppliers in their Areas

"TO WIRELESS SUPPLIERS."—Half inch in column spaces for names and addresses and particulars of apparatus supplied in the districts in this Directory are offered at the rate of 10/- per insertion, or 12 Insertions £5 5s. od. prepaid Communications with remittance should be sent to Scheff Publicity Organisation Ltd. 125 Pall Mall, London, S.W.1 Advertisers are included under one district without charge.

LONDON.

CAMBERWELL WIRELESS ASSOCIATION.

Hon. Sec.: 3d, Bushey Hill Road, Camberwell.

EAST LONDON RADIO SOCIETY.
Hon. Sec.: 60, East Ferry Road, Millwall, E.14.

HACKNEY AND DISTRICT RADIO SOCIETY.

Hon. Sec.: 218, Dagmor Road, South Hackney, E.9.

KENNINGTON RADIO SOCIETY.
Hon. Sec.: 2, Hollywood Road, S.W.10.

MERCHANT TAYLORS' SCHOOL SCIENTIFIC SOCIETY (WIRELESS SECTION).

Hon. Sec.: Merchant Taylors' School, E.C.1.

PADDINGTON WIRELESS AND SCIENTIFIC SOCIETY.

Hon. Sec.: 61, Burlington Road, Bayswater, W.2.

RADIO SOCIETY OF GREAT BRITAIN.

Hon. Sec.: 32, Quex Road, West Hampstead, N.W.6.

S. LONDON WIRELESS AND SCIENTIFIC CLUB.

Hon. Sec.: 69, Larcom Street, S.E.17.

WALTHAMSTOW AMATEUR RADIO CLUB.

Hon. Sec.: 49, Ulverston Road, E.17.

WANDSWORTH WIRELESS SOCIETY.

Hon. Sec.: 9, Birdhurst Road, Wandsworth, S.W.

WOOLWICH RADIO SOCIETY.
Hon. Sec.: 42, Greenvale Road, Eltham, S.E.9.

W. LONDON WIRELESS & EX. ASSOCIATION.

Hon. Sec.: 19, Bushey Road, Harlington, Middlesex.

SUPPLIERS:

American Hard Rubber Co. (Britain) Ltd., 13a, Fore Street, E.C.2.

Autoveyors Ltd., 84, Victoria Street, S.W.1.

G. Z. Auckland & Son, 395, St. John St., E.C.1.

S. G. Brown, Ltd., Victoria Road, North Acton, W.3.

Burndept, Ltd., 15, Bedford Street, Strand, W.C.2.

City Accumulator Co., 79, Mark Lane, E.C.3.

The Dubilier Condenser Co. (1921) Ltd., Ducon Works, Goldhawk Rd., Hammer-smith, W.12.

C. F. Elwell, Ltd., Craven House, Kingsway, W.C.2.

A. W. Gamage, Ltd., Holborn, E.C.1.

General Radio Co., 105, Gt. Portland Street, W.1

London (Cont.)

General Electric Co., Ltd., Magnet House, Kingsway, W.C.2.

Hambling Clapp & Co., 110, Strand, W.C.2.

Hestia Engineering Co., 32, Palmerston Road, W.3.

Igranic Electric Co., Ltd., 147, Queen Victoria Street, E.C.4.

Leslie McMichael, 32, Quex Road, N.W.6.

Mullard Radio Valve Co., Ltd., 45, Nightingale Lane, Balham, S.W.12.

Peto-Scott Co., Featherstone House, 64, High Holborn, W.C.1.

Radio Communication Co., Ltd., 34-35, Norfolk Street, Strand, W.C.2.

Radio Components Ltd., 12-13, Henrietta Street, Strand, W.C.2.

Radio Specialities: A. G. Chapman, 79, Branshot Avenue, Charlton, S.E.

Russell & Shaw, 38, Gt. James Street, Bedford Row, W.C.1.

Tingey Wireless Ltd., 92, Queen Street, W.6.

Wilton Wireless Co., Ltd., 120-124, High Street, Tooting, S.W.17.

ALDERSHOT.

ALDERSHOT & DISTRICT WIRELESS SOCIETY.

Hon. Sec.: Farnborough Road, South Farnborough, Hants.

BIRMINGHAM.

BIRMINGHAM EXPERIMENTAL WIRELESS CLUB.

Hon. Sec.: 110, Ivor Road, Sparkhill.

SUPPLIERS:

Burndept Ltd., 133, New Street, Birmingham.

Capstan Repetition Works, Park Road, Hockley, Birmingham.

Turnock's Telephone Works, 41, High Street, Aston.

Rogers, Foster & Howell, Ltd., Edward Road, Balsall Heath.

Messrs. Townshends, Ltd., Ernest Street.

BLACKBURN.

BLACKBURN (Y.M.C.A.) WIRELESS SOCIETY.

Hon. Sec.: Y.M.C.A. Blackburn.

BLACKPOOL.

BLACKPOOL & FYLDE & LYTHAM ST. ANNES WIRELESS SOCIETY.

Hon. Sec.: "The Poplars," 6, Seventh Ave., South Shore, Blackpool.

BOURNEMOUTH.

BOURNEMOUTH AND DISTRICT RADIO CLUB.

Hon. Sec.: 2, Iris Road, Winton, Bournemouth.

BRADFORD.

BRADFORD WIRELESS SOCIETY.
Hon. Sec.: 85, Emm Lane, Bradford.

BRADFORD-ON-AVON.

BRADFORD-ON-AVON RADIO SOCIETY.

Hon. Sec.: 4, Ivy Terrace, Bradford-on-Avon.

BRIGHTON.

BRIGHTON AND HOVE RADIO SOCIETY.

Hon. Sec.: 68, Southdown Ave., Brighton, Sussex.

SUPPLIERS:

H. J. Galliers, 32, St. James's Street, Brighton. Agent for Burndept Ltd.

BRISTOL.

BRISTOL & DISTRICT WIRELESS ASSOCIATION.

Hon. Sec.: 10, Priory Road, Knowle, Bristol.

BURTON-ON-TRENT.

BURTON-ON-TRENT WIRELESS SOCIETY.

Hon. Sec.: 68, Edward Street, Burton-on-Trent.

CAMBRIDGE.

CAMBRIDGE AND DISTRICT RADIO SOCIETY.

Hon. Sec.: 107, King Street, Cambridge.

CARDIFF.

CARDIFF AND SOUTH WALES WIRELESS SOCIETY.

Hon. Sec.: 37, Colum Road, Cardiff.

CIRENCESTER.

CORINIUM WIRELESS SOCIETY.
Hon. Sec.: The Old Vicarage, Cirencester.

COVENTRY.

COVENTRY AND DISTRICT WIRELESS ASSOCIATION.

Hon. Sec.: 14, Coundor Road, Coventry.

CROYDON.

CROYDON WIRELESS AND PHYSICAL SOCIETY.

Hon. Sec.: "Meadmoor," Brighton Rd., Purley, Surrey.

DARTFORD.

DARTFORD & DISTRICT WIRELESS SOCIETY.

Hon. Sec.: 84, Hawley Road, Dartford.

DERBY.

DERBY WIRELESS CLUB.

Hon. Sec.: "The Limes," Chellaston, Derby.

DEWSBURY.

DEWSBURY AND DISTRICT WIRELESS SOCIETY.

Hon. Sec.: Willow Grove, 34, Lee St., Ravensthorpe, Dewsbury.

DUNDEE.

DUNDEE & DISTRICT AMATEUR WIRELESS ASSOCIATION.

Hon. Sec.: 4, South Lindsay Street, Dundee.

EALING.

EALING AND DISTRICT RADIO SOCIETY.

Hon. Sec.: 52, Uxbridge Road, Ealing.

EDINBURGH
EDINBURGH & DISTRICT RADIO SOCIETY.

Hon. Sec.: 9, Ettrick Road, Edinburgh.

EPSOM.
ST. BARNABAS WIRELESS CLUB.

Hon. Sec.: Oakhurst, 32, Pound Lane, Epsom.

ESSEX.

SUPPLIERS:

Gordon Castagnoli, A.M.I.R.E., Rayne Road, Braintree.

FALKIRK.

FALKIRK & DISTRICT RADIO SOCIETY.

Hon. Sec.: Glenmorac, Falkirk.

FOLKESTONE.

FOLKESTONE & DISTRICT WIRELESS SOCIETY.

Hon. Sec.: 8, Longford Terrace, Folkestone.

GLASGOW.

SUPPLIERS:

Burndept Ltd., 93, Holm Street, Glasgow.

GUILDFORD.

SUPPLIERS:

Selwyn Weston, Playhouse Arcade, Guildford. Agent for Burndept Ltd.

GLOUCESTER.

GLEVUM RADIO & SCIENTIFIC SOCIETY.

Hon. Sec.: Gloucester.

GLOUCESTER WIRELESS AND SCIENTIFIC SOCIETY.

Hon. Sec.: 45, Denmark Rd., Gloucester.

HALIFAX.

HALIFAX WIRELESS CLUB AND RADIO SCIENTIFIC SOCIETY.

Hon. Sec.: Clare Hall Halifax.

SUPPLIERS:

Electrical Supply Stores, 5, Albert Terrace, King Cross.

HOUNSLOW.

HOUNSLOW AND DISTRICT WIRELESS SOCIETY.

Hon. Sec.: 20, Standard Rd., Hounslow.

HULL.

WIRELESS SOCIETY OF HULL.

Hon. Sec.: 79, Balfour Street, Holderness Road, Hull.

ILFORD.

ILFORD AND DISTRICT RADIO SOCIETY.

Hon. Sec.: 77, Khedive Road, Forest Gate.

ILKLEY.

ILKLEY & DISTRICT WIRELESS SOCIETY.

Hon. Sec.: "Lorne House," Richmond Place, Ilkley.

IPSWICH.

IPSWICH & DISTRICT WIRELESS SOCIETY.

Hon. Sec.: 46, Grove Lane, Ipswich.

LEEDS.

LEEDS & DISTRICT AMATEUR WIRELESS SOCIETY.

Hon. Sec.: 37, Mexborough Avenue, Chapeltown Road, Leeds.

SUPPLIERS:

British Wireless Supply Co., Ltd., 6, Blenheim Terrace.

Burndept Ltd., London Assurance House, Bond Place, Leeds.

LEICESTER.

LEICESTERSHIRE RADIO AND SCIENTIFIC SOCIETY.

Hon. Sec.: 269, Mere Road, Leicester.

LIVERPOOL.

LIVERPOOL WIRELESS SOCIETY.

Hon. Sec. No Secretary for Liverpool W.S.

LIVERPOOL (continued)

SUPPLIERS:

W. C. Barraclough, 10, South John Street, Liverpool. Agent for Burndept Ltd.

LOUGHBOROUGH.

LOUGHBOROUGH COLLEGE WIRELESS SOCIETY.

Hon. Sec.: Loughborough College, Leicestershire.

LOWESTOFT.

LOWESTOFT & DISTRICT WIRELESS SOCIETY.

"Gouzeacourt," Chestnut Avenue, Oulton Broad, Suffolk.

LUTON.

LUTON WIRELESS SOCIETY.

Hon. Sec.: Hitchin Road Boys' School, Luton Beds.

MANCHESTER.

MANCHESTER RADIO SCIENTIFIC SOCIETY.

Hon. Sec.: 16, Todd Street, Manchester.

MANCHESTER WIRELESS SOCIETY
Hon. Sec.: 2, Parkside Road, Withington, Manchester.

SUPPLIERS

Metropolitan Vickers Electrical Co., Ltd., 14, Long Millgate, Manchester.

W. C. Barraclough, North-west Depot for Burndept Ltd., 61, Bridge Street, Manchester.

MIDDLESBROUGH.

MIDDLESBROUGH WIRELESS SOCIETY.

Hon. Sec.: Nunthorpe, S.O., Yorks.

NEWBURY.

NEWBURY & DISTRICT WIRELESS CLUB.

Hon. Sec.: The Sillies, Arthur Road, Newbury.

NEWCASTLE-ON-TYNE.

NEWCASTLE & DISTRICT AMATEUR WIRELESS ASSOCIATION.

Hon. Sec.: 51, Grainger St., Newcastle-on-Tyne.

SUPPLIERS:

Travers, Ltd., 73 & 77, Pilgrim Street, Agents for Burndept Wireless Apparatus.

N. MIDDLESEX.

N. MIDDLESEX WIRELESS CLUB.

Hon. Sec.: Nithsdale, Eversley Park Rd., Winchmore Hill.

NOTTINGHAM.

NOTTINGHAM AND DISTRICT RADIO EX. ASSCN.

Hon. Sec.: 99, Musters Road, W. Bridgford, Nottingham.

SUPPLIERS:

Pearson Bros., 54, 55, 56, Long Row, Nottingham. Agent for Burndept Ltd.

OLDHAM.

OLDHAM LYCEUM WIRELESS SOCIETY.

Hon. Sec.: 16, South-hill Street, Oldham.

PLYMOUTH.

PLYMOUTH WIRELESS AND SCIENTIFIC SOCIETY.

Hon. Sec.: 9, Ryder Road, Stoke Devonport.

PORTSMOUTH.

PORTSMOUTH AND DISTRICT WIRELESS ASSOCIATION.

Hon. Sec.: 34, Bradford Road, Southsea.

PRESTON.

PRESTON SCIENTIFIC SOCIETY.

Hon. Sec.: 19, Melbourne St., Preston, Lancs.

PRESTON.

DICK KERR WIRELESS SOCIETY.

Hon. Sec.: Dick Kerr United Club, Ashton Park. Preston.

POOLE.

EAST DORSETSHIRE WIRELESS SOCIETY.

Hon. Sec.: Abbotsford, Serpentine Road, Poole.

SUPPLIERS:

E. T. Chapman, A.M.I.E.E., Wireless & Electrical Engineers, 38, Serpentine Rd., Poole. Agent for Burndept Ltd.

READING.

READING RADIO RESEARCH SOCY.

Hon. Sec.: Broadway Buildings, Station Road, Reading.

SUPPLIERS:

Universal Lighting Co., 37 Market Place, Reading.

RUGBY.

RUGBY AND DISTRICT WIRELESS CLUB.

Hon. Sec.: "Glebe Cottage," Clifton on Dunsmore, Nr Rugby.

ST. AUSTELL.

ST. AUSTELL W-T CLUB.

Hon. Sec.: 26, Fore Street, St. Austell, Cornwall.

SCARBOROUGH.

SCARBOROUGH AND DISTRICT WIRELESS CLUB.

Hon. Sec.: Snainton, Yorks.

SHEFFIELD.

SHEFFIELD AND DISTRICT WIRELESS SOCIETY.

Hon. Sec.: 18, Lindon Avenue, Woodseats, Sheffield.

SLOUGH.

SLOUGH AND DISTRICT RADIO SOCIETY.

Hon. Sec.: Raversham House, Dolphin Road, Slough.

SMETHWICK.

SMETHWICK WIRELESS SOCIETY.

Hon. Sec.: Radio House, Wilson Road, Smethwick.

SOUTHEND-ON-SEA.

SOUTHEND AND DISTRICT WIRELESS CLUB.

Hon. Sec.: 4, Wimborne Road, Southend-on-Sea.

STOKE-ON-TRENT.

STOKE-ON-TRENT WIRELESS & EXPERIMENTAL SOCIETY.

Hon. Sec.: 360, Cobridge Road, Hanley, Stoke-on-Trent.

SUSSEX.

SUSSEX WIRELESS RESEARCH SOCIETY.

Hon. Sec. No Secretary.

SUTTON (Surrey).

SUTTON & DISTRICT WIRELESS SOCIETY.

Hon. Sec.: "Stanley Lodge," Rosebery Road, Cheam, Surrey.

NORTH SHIELDS.

BOROUGH OF TYNEMOUTH Y.M.C.A. RADIO & SCIENTIFIC SOCIETY.

Hon. Sec.: 37, Borough Road, North Shields.

TONBRIDGE WELLS.

SUPPLIERS:

H. Featherstone, 22, London Road, Agents for Burndept Wireless Apparatus.

TORQUAY.

SUPPLIERS:

Sydney Truscott, 44, Fleet Street. Sole Agents for Burndept Wireless Apparatus.

WALLASEY.

WALLASEY WIRELESS AND EX. SOCIETY.

Hon. Sec. 24, Vaughan Road New Brighton.

DIRECTORY (continued)

WATFORD:

WATFORD GRAMMAR SCHOOL
WIRELESS CLUB.
Hon. Sec.: 143, Ridge Street, Watford.

WESTON-SUPER-MARE.

WESTON-SUPER-MARE WIRELESS
SOCIETY.
Hon. Sec.: Homeleigh, Ellenborough Pk.
(S.), Weston-super-Mare.

WOLVERHAMPTON.

WOLVERHAMPTON & DISTRICT
WIRELESS SOCIETY.
Hon. Sec.: 252, Gt. Brickkiln Street,
Wolverhampton.

YEOVIL.

SUPPLIERS
Western Counties' Electrical Engineering
Co., Middle Bank Chambers, Middle
Street. Agents for Burndep't. Wireless
Apparatus.



**Can I help you?
I will give you £50**

If I fail to produce 7,000 testimonials
from others I have helped to
A SUCCESSFUL CAREER

Yours to Success

J. H. Bennett

*Every man is the architect of his own
fortune!*

We Teach **ADVICE FREE** Learn a
by **Most Moderate** Trade or
Post. **Charges.** Profession
Payable Monthly

We specialise in all Exams, Wireless, Elec-
tricity, P.M.G., C.G.I., A.M.I.E.E., and B.C.D.

Write for one of our **FREE BOOKLETS** on any of the
following subjects:—

- | | | |
|------------------------|------------------------|------------------------|
| Architectural Drawing | Engineering | Pattern Making |
| Building Construction | Foundry Work | Salesmanship |
| Clerk of Works' Duties | Internal Comb. Engines | Sanitation |
| Aviation | Marine Engineering | Shipbuilding |
| Boiler Engineering | Mathematics | Structural Engineering |
| Boiler Making | Matriculation | Surveying & Levelling |
| Chemistry | Metallurgy | Telegraphy & Telephony |
| Civil Engineering | Mining | Wireless Telegraphy |
| Concrete and Steel | Mine Surveying | Special Course for |
| Draughtsmanship | Motor Engineering | Apprentices |
| Electricity | Naval Architecture | |

If you are preparing for any exam, ask our advice. All particulars free of charge. Parents should seek our advice for their sons. If you are interested in any of the subjects mentioned above, write naming the subject, and we will send you our **FREE BOOKLET**. Please state your age. Courses specially combined to meet all requirements.



**WIRELESS
FOR ALL**

6d.
NET.

**SIMPLIFIED
WIRELESS**

1/-
NET.

Of all Booksellers, or direct
(1/9 post free) from—

Radio Press, Ltd,

DEVEREUX COURT LONDON, W.O.2

THE
"HESTAVOX" II.

Licensed under (G.P.O. Regd. No. 2005). Fully Approved
MARCONI PATENTS. by P.M.G.

BROADCAST RECEIVER
(TWO VALVE: 1 H.F., 1 DET.)



PRICE
exclusive
of accessories
£12 - 7 - 6

PRICE
including
all accessories
£19 - 16 - 0

This is an ideal instrument for general home use. It is fitted with variable reaction, and will accurately tune in Broadcast Telephony from distances within 150 miles radius. "Hestia" L.F. Amplifying Units can be added as required in order to increase the Signal Strength.

ASK YOUR DEALER FOR A DEMONSTRATION

Our Loose Leaf Catalogue of above, also other types of Crystal and Valve Apparatus, post free 6d.

The **"HESTIA" ENGINEERING COMPANY,**
32 PALMERSTON ROAD,
1 min. South Acton Stn. ACTON, LONDON, W.3.
(N.L. and District Rlys.)

Showrooms open
9 a.m. — 6 p.m.
Telephone:
Chiswick - 586



No. 1 Radiocraft Set, for building crystal receiver for Broadcasting, Shipping, Aeroplanes, etc. Panel drilled, engraved, ready for mounting, first grade-nickel plated fittings throughout. Complete with aerials, etc., ready for building up, £4.

Radiocraft
The hall-mark of the best apparatus for the experimenter



No. 2 Radiocraft Set, a complete 3-valve set for amplifying the signals received on No. 1 Set. All fittings provided with terminals. Set with 50-V.A.H. filament battery, 36-volt Anode Battery, 3 L.F. Amplifying Units, 3 valves, polished oak case. £11 15s. 0d. each.

Radiocraft is a complete line of wireless components. These components have been selected and designed so that the Experimenter has all the essential parts for the construction of different and improved circuits at his disposal and by the provision of terminals, whenever necessary, such operations as soldering are eliminated. The items illustrated are typical.



Mullard grid resistance, 4 megohms, and Dubilier .0003 mfd. condenser. 7/6 each.



Air space coils—very low self capacity, entirely enclosed in black moulded case and fitted with full grip terminals. Can be used as variable inductance, coupling or reaction coils. No. 1 Broadcast, 7/6 each, No. 2 Shipping, 10/- each, No. 3 Eiffel Tower, 12/6 each.

Radiocraft Components.

Tell us the circuit you propose to build as well as the names of the individual items you require, and we may be able to suggest a selection better suited to your purpose.

For Radiocraft work you need an Experimental Licence and in reference to this, the Postmaster-General in the House of Commons said on 27th July, 1922:—

“ Provision will be made under which Amateurs who construct their own receiving sets will be allowed to use them.”

Send us your Order To-day.

C. F. Elwell, Ltd.

Craven House, Kingsway, London, W.C.

Telephone: Museum, 1384.



Special Wireless Plugs—take the standard tags of Brown, Sullivan, Radiocraft, and other telephones, without solder or screwdriver. Instant bull-dog grip and immediate release when desired. For one pair telephones, 7/6 each. For two pairs, 10/- each.



Special wireless Jacks for all purposes. Type S.C. for putting extra telephone in circuit, 3/6 each. Type D.F. connects telephones to desired valves, with plug out; telephones, transformer and valves not in use are disconnected. Excellent for multi-valve sets. 6/6 each.

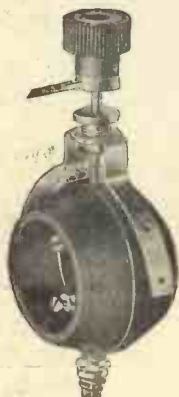

Variometer for tuning inductances, reaction capacity amplifiers, reaction coils, etc. Mounted by drilling only one hole in panel. Nickel plated fittings throughout. 9/- each.



Bull dog grip terminals for fixing to panels, strip connectors, etc. Take standard tags, give instant grip and immediate release when desired. 1/6 each.

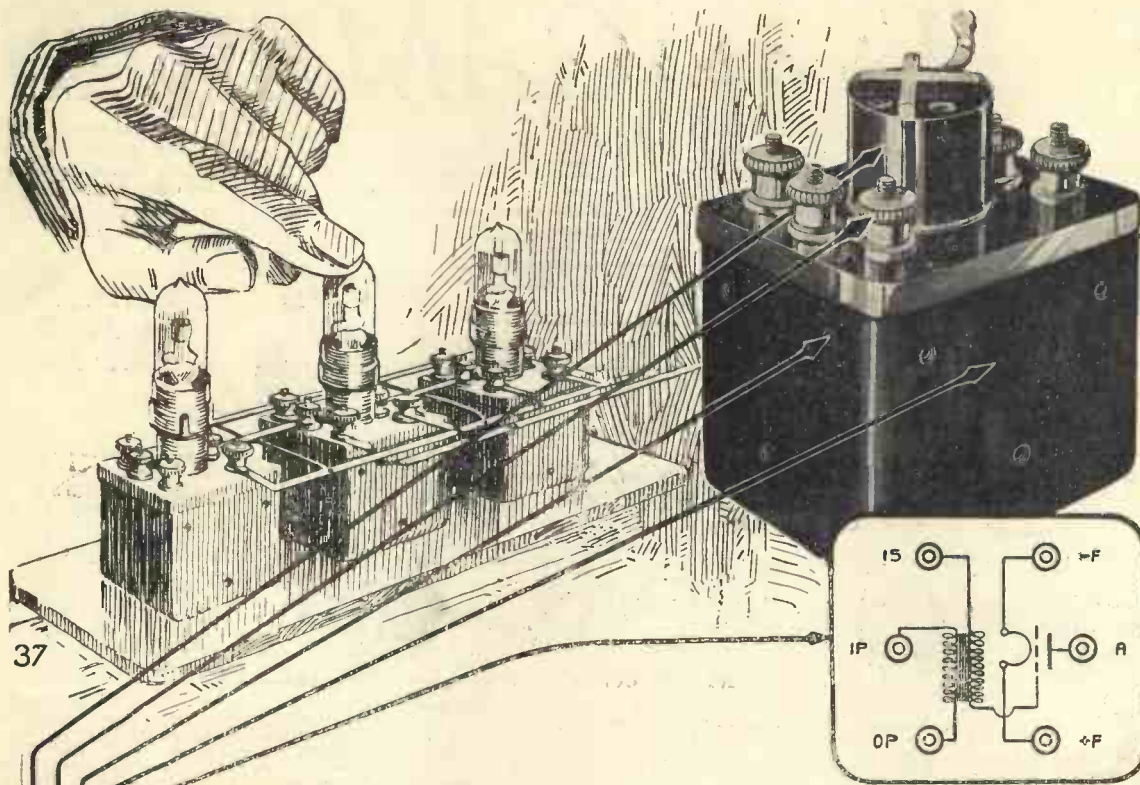

37

No need to spend time making these connections. The Elwell amplifying unit contains them ready made.

The intervalve transformer is contained in an iron case, allowing units to be placed close together without howling.

Tapped holes in two sides and base make fixing easy. The unit will also stand alone.

All connections are embedded in compound and brought out to terminals. No soldering necessary. The perfect insulation of the grid connection ensures silent operation.

The valve holder has specially long leakage paths and an earth clip.

Amplifying made Easy.

When building a valve set, do not buy intervalve transformers. Use Elwell Amplifying Units. They save time, money, and trouble.

When buying a valve set, select one using these units. They enable the manufacturer to give you a better job at a lower cost.

The unit featured is a note magnifier. Elwell Amplifying Units are entirely British made.

OVERALL DIMENSIONS : $3\frac{1}{2}$ " x $2\frac{5}{16}$ " x 2"

The Elwell L.F. Amplifying Unit, when provided with a valve and connected as marked on the terminals, is all that is necessary to give one stage note magnification to your existing set.

Two, three or more units may be coupled as shown, to give as many stages of note magnification as required.

Rectifying Unit, L.F. Amplifying Unit, H.F. Amplifying Unit,
 19/6 each. 39/6 each. 29/6 each.

Send us your order to-day

C. F. ELWELL^{LD}

Craven House, Kingsway, London^{W.C.} 2.

Telephone : Museum 1384

Telegrams : "Elradioeng, Westcent, London"

Cables : Elradioeng London

Western Union Code

ELWELL
High Power
Wireless
Stations

Oxford

Cairo

Northolt

Horsea
Island

Eiffel
Tower

Lyons

Nantes

Rome

& others

ELWELL
WIRELESS



GET IT at GAMAGES

WHY Because you are dealing with the PIONEERS OF BETTER APPARATUS FOR AMATEURS—a Firm with too high a reputation to supply Wireless Goods below the high standard of efficiency the Amateur must have to make his experiments successful—his hobby worth while.

CALL AT HOLBORN and see any set demonstrated. Look over the large and varied stock of WIRELESS SUNDRIES. Avail yourself of the Expert Knowledge of our staff. That costs NOTHING. And Gamage Prices are the keenest in the Trade.

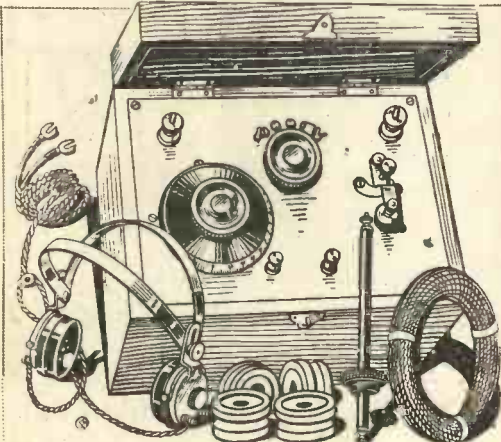

Fully Licensed CRYSTAL RECEIVER.
Fully Licensed and passed by Postmaster-General. The neatest, most efficient and most compact receiver to-day. The Crystal combination is the "Perikon," being Zincite and Copper Pyrites. The wave-length covered is 170 to 800 metres. Beautifully finished and mounted in polished mahogany box, and certainly makes a suitable and desirable present. The total cost of this instrument with high-resistance 'phones, 100ft. Aerial wire, Aerial insulators and lead-in tube is **£5 19 6**

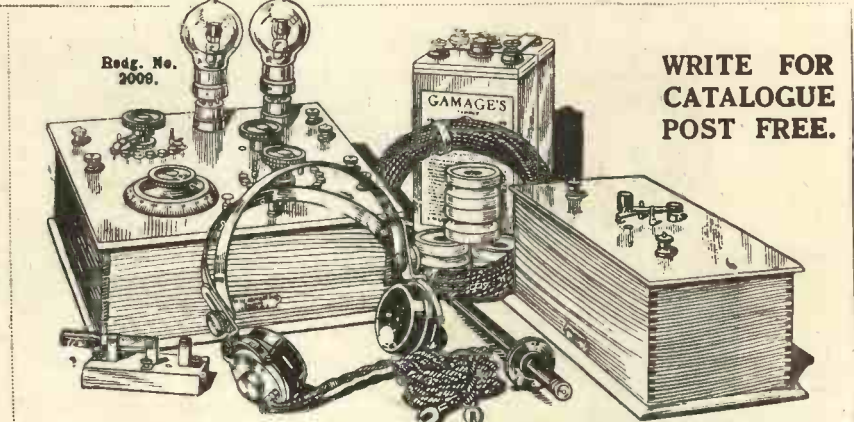

The "SONUS" Two Valve BROADCAST RECEIVER

Consisting of one High Frequency and Detecting Valve. Telephony from Broadcasting Stations up to 80 miles distant can be satisfactorily received on telephones and Low Frequency Amplifying Valves can be added, to increase the volume of music for purposes of operating a loud speaker or several pairs of 'phones. The number of Low Frequency Valves required depends upon the distance from the Transmitting Station. Music and speech are exceptionally clear on this Broad-

cast Receiver. The Set has been designed to work on the average aerial, and has a wave range of 300 to 3,000 metres, which enables the owner to receive the well-known Time Signals from Paris. The range of reception of Speak Signals is approximately 150 to 2,000 miles. This set is in accordance with the requirements of Postmaster-General, and has been passed by him. **£21**
Price, complete as shown,

WRITE FOR CATALOGUE POST FREE.

LARGEST STOCKS OF WIRELESS SUNDRIES IN THE WORLD.

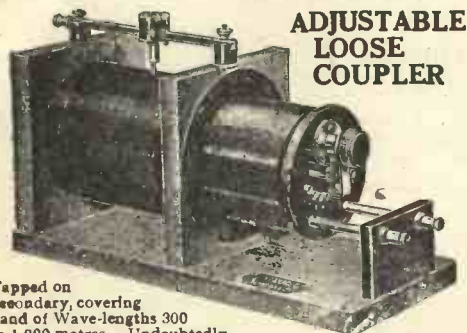

ADJUSTABLE LOOSE COUPLER

Tapped on Secondary, covering band of Wave-lengths 300 to 1,000 metres. Undoubtedly the most efficient for shorter wave-lengths, especially with crystal receivers. Price **47/6**
Superior type with long and short wave switch, **£3: 17: 6**

VARIABLE CONDENSER

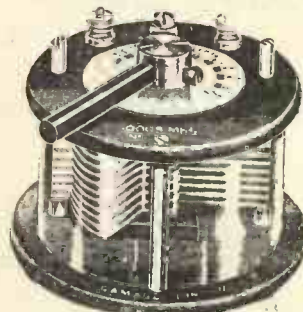

AIR DIELECTRIC TYPE

Faraday House Calibration. These condensers are the best obtainable. Of the finest workmanship, electrically and mechanically perfect.

- No. 1.—As illustrated, Circular, with 10 fixed and 9 moving vanes and a maximum capacity of .0003 mfd. Fitted with matt ebonite top and base, and engraved ivory scale. Price **25/-**
- No. 2.—As above, with .00045 mfd capacity. Price **33/6**
- No. 3.—.0005 mfd. Circular, with ebonite top, bottom and sides, and engraved ebonite scale. Price **40/-**
- Ditto in Square Mahogany Case **32/6**
- No. 4.—.0006 mfd. Circular with ebonite top and base. Encased in celluloid. Price **40/-**
- No. 5.—.0007 mfd, otherwise as No. 4. Price **50/-**
- No. 6.—.0015 mfd. Square; ebonite top, mahogany container, engraved ebonite scale. Price **39/6**
- No. 7.—.0015 mfd. Square, with sloping panel. Engraved ebonite scale. Price **70/-**

PERMANITE DETECTOR

Designed particularly for use with crystals requiring a fine wire contact such as "Permanite," Silicon, Galena, etc., and as such is unequalled by any other detector. The crystal is enclosed in an air-tight celluloid vessel which keeps it free from dust—the enemy of all crystals. Ball joint action with variable pressure. Mounted on ebonite base, 4 1/2 by 5 1/8 in. Price (without crystals) **15/6**

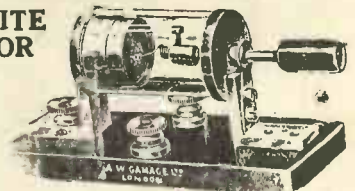

AMAZING WIRELESS CATALOGUE—FIRST EDITION EXHAUSTED. SECOND EDITION NOW READY. MENTION "MODERN WIRELESS" WHEN APPLYING.



HIGH-TENSION BATTERY BOX

Improved design with base board and green baize bottom. Finished in polished mahogany with ebonite top. Designed to give total output of 105 volts varied in seven steps of 15 volts. Price, container only, Complete with Batteries, ready for use, **55/-**
Small size to take 60 volts, 4 tappings, container only **15/6**
Complete with Batteries, ready for use, 31-Batteries, 3/9 per unit of 15 volts.

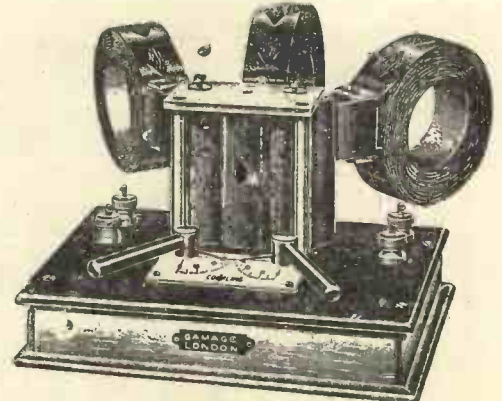

HONEYCOMB COIL HOLDER

Three-coil holder, geared to enable fine adjustment. Finished in beautifully polished mahogany and lacquered brass fittings; ebonite base and pillars. Price **32/6**
Smaller type, 20/-

MODERN WIRELESS UNITS DEVELOPED ON THE LATEST PRINCIPLES



PLUG DUO-LATERAL
COILS



"TRIPLUG"
COIL HOLDER.



GIMBAL DUO-LATERAL
COILS.

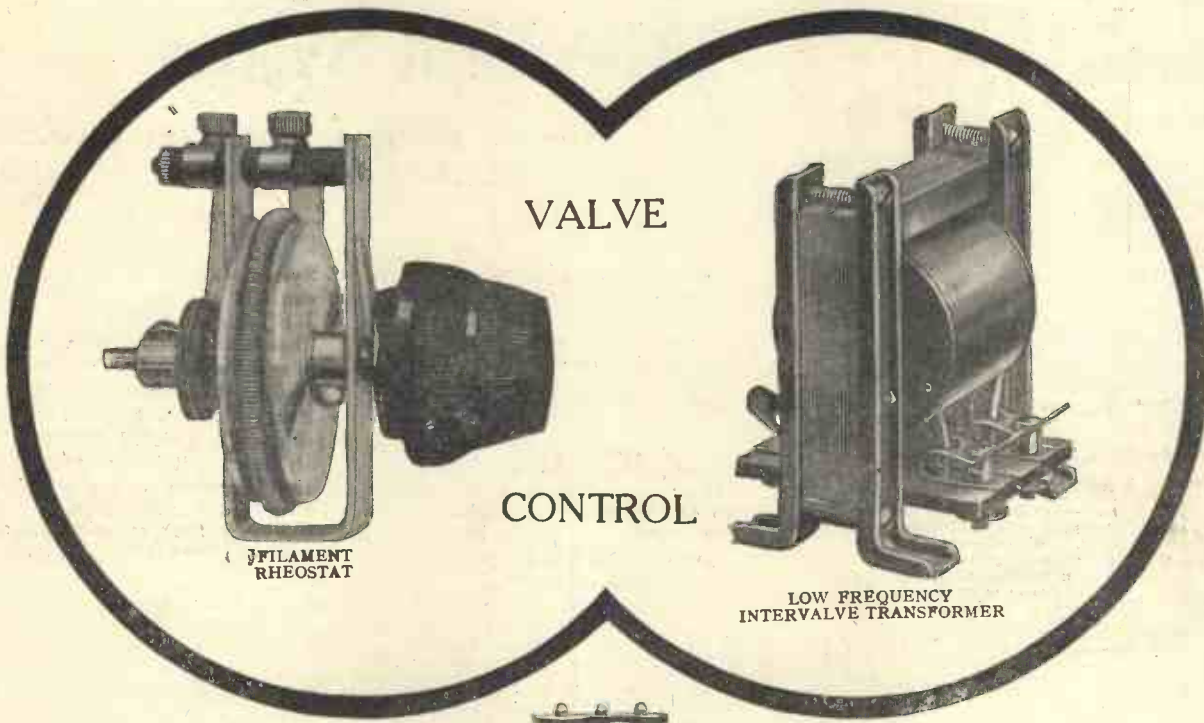

VALVE

CONTROL

FILAMENT
RHEOSTAT

LOW FREQUENCY
INTERVALVE TRANSFORMER

"TRIPLUG" COIL HOLDERS
TABLE & PANEL MOUNTING

TAPPED INDUCTANCES

DUO-LATERAL
INDUCTANCE COILS



"Gimbolder" Coil Holder
Write for Pamphlets V.1.

"GIMBOLDER"
TUNING INDUCTANCES
FOR
SHARP TUNING,
VARIO-COUPLER
AND
VARIOMETER COMBINED

Manchester—30, Cross Street.
Birmingham—73/4, Exchange Buildings
Glasgow—50, Wellington Street.

149, Queen Victoria Street.
LONDON.



Cardiff—Western Mail Chambers.
Bradford—18, Woodview Ter., Manningham
Newcastle—90, Pilgrim Street.

Works :
Elstow Road, BEDFORD.

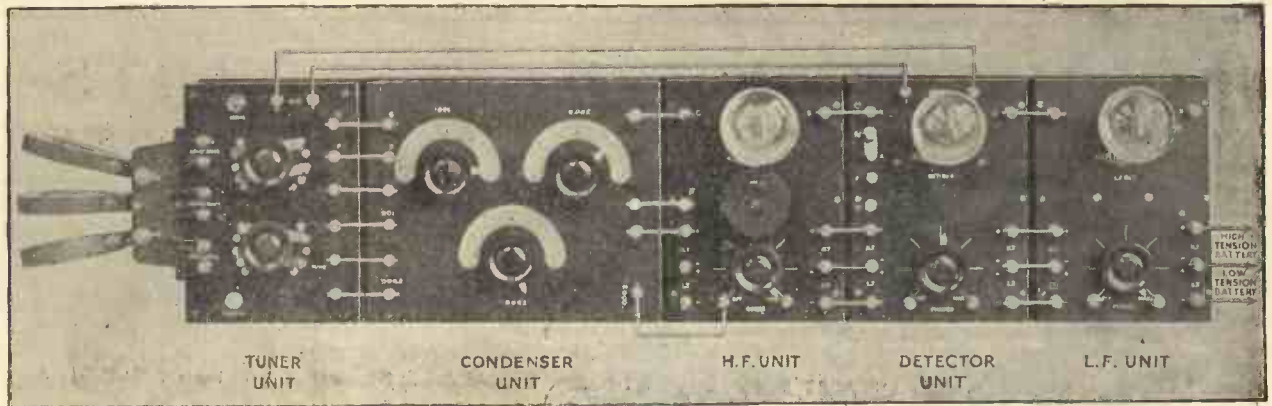

All Peto-Scott Standardised Radio Units sold under licence from the Marconi Co.

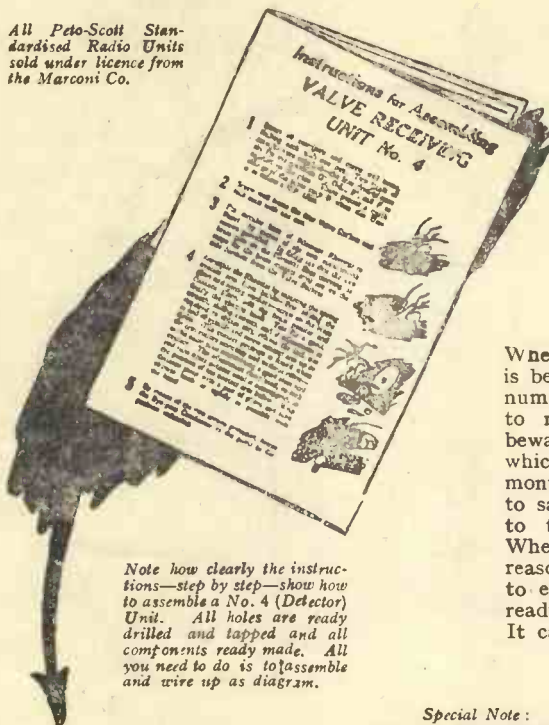

Note how clearly the instructions—step by step—show how to assemble a No. 4 (Detector) Unit. All holes are ready drilled and tapped and all components ready made. All you need to do is to assemble and wire up as diagram.

Special Note:
Full instructions, either as a fully illustrated Folder or a Set of Blueprints, are supplied with every Set of Parts. All Sets neatly boxed in special containers.

Eventually you'll need the Unit System

—no other method allows such flexible and economical control of your Station.

When a man takes up Radio he is bewildered by the already large number of Instruments from which to make a selection. Let him beware of spending money on a Set which he will out-grow in a few months. His first Set will cease to satisfy him as soon as he gets to the *critical* stage in Radio. When he begins to understand the reason-why in Radio he will want to experiment for himself. On a ready-built Set this is impossible. It can only be done on the Unit

System—a method by which you can add as many Valves (H.F. or L.F.) as one likes. This is the Peto Scott way. And in addition each Unit can be assembled by the veriest novice in Radio. Every instrument, whether in sets of parts or finished, represents the absolute limit in efficiency. They are instruments you would be proud to own. *Our new Booklet (6d. post free) explains the whole System. Send for it to-day.*

PRICE LIST OF SETS OF PARTS.	
Tuner Unit	27/6
No. 4, Detector Unit	17/6
No. 5, L.F. Amp. Unit	38/6
No. 3, H.F. Amp. Unit	13/6
Mahogany Cabinets to fit	3/6
Postage 9d. per unit extra, paid on orders over £2	

The Peto-Scott Co..

Featherstone House,
64, HIGH HOLBORN, W.C.1.



MARSHALL AD

LISTOLEON

RADIOPHONE RECEIVING SETS

ARE THE

MOST SIMPLE AND
COMPACT ON THE MARKET

No Skill Required

An absolute Novice is bound to
be successful at once with our
:: :: instruments. [:: ::



CALL OR WRITE FOR FREE INFORMATION

We can Help You on Your Wireless Way



All Installations are complete
in every detail and approved
by P.M.G.

NO EXTRA EXPENSES

No More Dull Evenings

TRADE ENQUIRIES INVITED
VERY
ADVANTAGEOUS TERMS

RADIOPHONES, LTD.,

"SIMPLICITY
WITH
SATISFACTION."

1b GRANVILLE PLACE,
MARBLE ARCH,
LONDON,
W.1.

TELE { PHONE: MAYFAIR 1250
GRAMS: RADPHOLIM, BAKER,
LONDON.



THE "SENSIFONE"

CRYSTAL RECEIVING SET

AND

DOUBLE HEAD-PHONE

FULLY APPROVED BY H.M. POSTMASTER-GENERAL.

Highly Polished Solid Oak Case and Ebonite Panel
9 1/2" high, 9 1/4" wide, 8" deep.

"Perikon" Crystal Detector with ball joint adjustment.

Price £5 - 10 - 0

complete with 4000 ohm double head-phone, 100 foot Aerial
two Shell Insulators and Ebonite leading-in Tube.

Additional Head-Phones 27/6. Write for descriptive leaflets

THE MOST
RELIABLE AND
SATISFACTORY
COMBINATION
ON THE
MARKET FOR
LOCAL BROAD-
CAST CONCERTS



TOWNSEND'S LTD.,
(Members of the British Broadcasting Co.)
ERNEST ST., BIRMINGHAM.
Established 1881

Agents and Showrooms
LONDON COWARD & CO., 81 CHARLOTTE ST., W.1
MANCHESTER - COULSTON & CO., 5, CROSS ST.,
NEWCASTLE R. F. SUNDERLAND, MILBURN HOUSE
GLASGOW - CLARKSON, HOOD & CO., 45, HOPE ST.



BUY FROM MANUFACTURERS

T. T. W.

Wireless Telephones with Headbands

6-foot cord and tag. Beautiful design and finish. Double plate magnets. Accurately machined parts. Replaceable coils to any resistance. Fully guaranteed. 4,000 ohms. £1 0s. 0d. per pair. Postage 9d.

SINGLE RECEIVERS, with cord and handle,
2,000 ohms. 7/6 each.

The "Turnockphone" Loud Speaker

Fitted with beautiful curved horn. Stands 26ins. high. Superior finish. Designed specially for sound expansion. Remarkably sensitive, being fitted with a four phase sound-producing unit. £4 4s. 0d.

Sent on appro. on half deposit. Carriage 4/6.

CATALOGUE CONTAINING HINTS ON CARE USE AND TESTING
OF TELEPHONE.

TURNOCK'S TELEPHONE WORKS, 41 High St., Aston, BIRMINGHAM

BRITPHONE No. 4

P.O. Regd. No. 0181.
Cabinet measurements, 20½ in. X 16½ in. X 9½ in.
Range covers 200—25000 metres wave length.

AN excellent 4 Valve Broadcast Receiver in polished mahogany Cabinet with folding panelled doors fully in keeping with the general appearance of the instrument. The receiving panel is of Radion Mahoganite.

The 4 Valves include 1 H.F., 1 Rect., and 2 L.F. Steps. The last valve by means of a switch, acts as either an ordinary magnifier or a power valve for use with any Loud Speaker. The high tension voltage on this valve can be anything up to 400 Volts, thereby obtaining tremendous increase in volume of sound. This is extremely suitable for entertainments in large halls or out in the open.

Price Complete with all accessories, including 4 Valves and **40 gns.** coils up to 4000 metres,
Ready for immediate use.

BRITPHONE No. 2

THE "BRITPHONE" No. 2 can be used simply as a Crystal Receiver, or as a combination of crystal and valve. The addition of the valve is obtained by a special switching device. This Set gives extremely clear reception of Music, Speech, and Morse Code.

It is contained in Solid Mahogany case of excellent workmanship and finish. Eminently suitable for Broadcast Concerts.

The price includes Coils up to 2000 metres, Aerial Wire, Insulators, Headphones, Valve Accumulators (4 Vol. 60 amp), H.T. Battery **£13 10** (60 volts) and also all Royalties of the British Broadcast Company.

By the addition of other "plug-in" coils, the range can be increased up to 25,000 metres.

All "Britphone" Apparatus is approved by the Post-master General and is manufactured under the Marconi Patents.



London Showrooms
Our new Showrooms are well situated, excellently appointed, & carry a full stock of all BRITWIRE manufactures.
Demonstrations Daily.
64, Frith St., off Shaftesbury Avenue, W.1

British Wireless Supply Co., Ltd.

Head Office : 6, Blenheim Terrace, Leeds.
Telephone 26926

18, ELDON SQUARE, NEWCASTLE
Telephone : Newcastle-on-Tyne, 360 City.
33, HIGH STREET, SOUTHAMPTON.
Telephone : Southampton 403.
11, CHURCH STREET, WEST HARTLEPOOL.
Telephone : West Hartlepool 373.
8, CORPORATION STREET BELFAST.

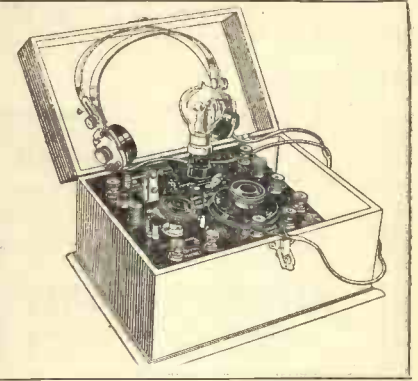

TYPE F. "Featherweight."
Actual weight, including cords,
is 6 ozs. only.

BROWN'S

"Featherweight"

HEADPHONES

British and Best

The Finest Headphones Procurable for

30/-

This price is for one pair of either 120 or 4000 ohm phones, including cords of good quality.

Catalogue Post Free.

Head Office and
Works :
Victoria Road,
North Acton, W.3

S. G. BROWN, Ltd.

London
Showrooms :
19 Mortimer St.,
London, W.1

"We Reply by Return"

APPARATUS AT YOUR PRICE

The following are a few items from our lists, and should interest you. Every article carries our money-back guarantee with it.

- Filament Resistance Panel Mounting .. 2/6
- Crystal Detector Single cup 2/9
- Crystal Detector Double cup 3/6
- Crystals, all kinds, per packet 8d.
- Woods Metal, per stick 8d.
- Buzzers for testing Crystals 2/6
- Inductance Sliders to fit $\frac{1}{4}$ " rod 9d.
- Brass Square rod $\frac{1}{4}$ " x $\frac{1}{4}$ ", per foot .. 6d.
- Brass Rod, round, $\frac{1}{4}$ " .. " .. 6d.
- ditto $\frac{3}{16}$ " .. " .. 5d.
- ditto $\frac{1}{8}$ " .. " .. 3d.
- Strip Brass $\frac{1}{2}$ " x $\frac{1}{8}$ " 6d.
- Aerial Wire 7/22s. Stranded Copper
per 100 ft. 4/6
- Insulators, Egg Pattern, each 3d.
- Voltmeter 0-6 volts 6/8

Postage Extra on all the above.

Send for your copy of our FREE List

ELECTRICAL SUPPLY STORES,
5, Albert Terrace, King Cross, Halifax.



YOUR GUARANTEE

YOUR friends can also enjoy the music, speech, and morse messages received on your Crystal or Single Valve set, provided you will connect to same one of our amplifying units.

Single Valve Amplifier £3 - 15 - 0
Two Valve Amplifier £9 - 0 - 0

These prices include all fees to the B.B. Co. & Marconi Co.

The two valve amplifier includes a special switching device, enabling same to be permanently connected to your original set without interfering with reception. When increase in volume of sound is required, you can easily obtain same by switching in either one or both valves on the amplifier.

When both amplifying valves are in use, reception is sufficiently great to work a Loud Speaker.

We also supply complete Broadcast Receiving Sets and all component parts

110, STRAND, LONDON, W.C.

Telephone : Gerrard 8806.

"CASTAPHONE"

(Regd. Trade Mark)

Receivers for Broadcast Reception.



CASTAPHONE
T.1.
RECEIVER

G.P.O.
REGD. NO.
1017.

The most efficient one-valve receiver made. Effective range, 30-40 miles. Simple to work, giving perfect reception of Broadcast music and telephony. Note Magnifiers may be added, making a two or three valve set, using the same set of batteries as used for receiver. Price £5/15/0 less valve, or including Marconi valve. Batteries, superior double Head Phones, Aerial Wire and Insulators, making a Complete Station, £10/15/0. (Prices include Broadcasting Commission and Marconi Royalty.)

"Castaphone" apparatus are not designed to compete with cheap sets which must be unsatisfactory in use; they represent a standard in design and workmanship, giving results that cannot be bettered.

Write for full particulars, gratis. Illustrated List of Broadcast and General Apparatus, post free, 4d.

Gordon Castagnoli, A.M.I. RadioE.

Manufacturer of Distinctive Wireless Apparatus,

BRAINTREE, ESSEX.

Our Great . . .

"HERTZITE" CRYSTAL RECEIVING SET

Price 67/6 Free Carriage

Including B.B.C. Commission

IS THE ONE YOU WANT FOR

BROADCASTING.

Range 40 Miles.

"HERTZITE" CRYSTALS,
2/6, Post Free.

Mounted in our Patent Detector, 5/6. Post free.

See you get our "HERTZITE" and not some substitute

VALVES: "ORA," "XTRAUDION," "C.V.C." and
"R.M.R." 15/- each

RUSSELL & SHAW,

38, Great James Street, Bedford Row. W.C.1.

Reached from Holborn through Brownlow Street (near Chancery Lane Tube Station) or Hand Court.

THE "AUTOVEYORS"
3-Electrode
Variable Condenser

(BRITISH PATENT 17703/22)

Is the most efficient precision controller of oscillations in Radio circuits. It comprises three sections, each consisting of a tier of parallel plates of one-third disc area. The centre section is spindled and knobbed, and permits a variation of capacity over 360 deg. Both side sections are spindled and knobbed and permit Vernier control of extreme precision. Thus, whilst providing all the essentials of the ordinary 2-Electrode Variable Condenser, it affords the added advantage of the coupling of the third Electrode, which may be applied in a thousand and one ways.

In **AERIAL CIRCUITS** the 3-E.V.C. permits the application of capacity from Zero Series to Maximum Parallel by a single operation. Additional switches are unnecessary, and detuning from Series to Parallel is avoided.

In **CLOSED CIRCUITS** it provides a precision-controlled Static coupling for synchronous super-regeneration or relay radiation choke of unbounded possibilities.

In **GRID CIRCUITS** it permits the employment of regenerative static influence upon the input.

In **ANODE CIRCUITS** it affords definite control of by-pass, stability and regenerative applications.

In **OSCILLATOR CIRCUITS** the 3-E.V.C. ensures precision control of synchronism.

Full Particulars from the Sole Patentees:—

AUTOVEYORS, LTD.

Radio Engineers and Contractors

84 VICTORIA STREET, LONDON, S.W.1

Phone: VICTORIA 309

EBONITE

**SHEETS, RODS, TUBES,
 MOULDINGS, PANELS**

Tons of Sheets in London Stock suitable for all requirements of the Wireless Trade.

ENQUIRIES INVITED.

RADION

(Regd. Trade Mark)

This is the latest product of our Factories—the supreme insulating material for high grade sets, which in grain and colour closely resembles mahogany. Manufacturers looking for something distinctive are invited to write us for further particulars.

AMERICAN HARD RUBBER CO.
 (Britain) LTD.

13a Fore Street, London, E.C.2

Wholesale only.]

Telephone—12754 Central.

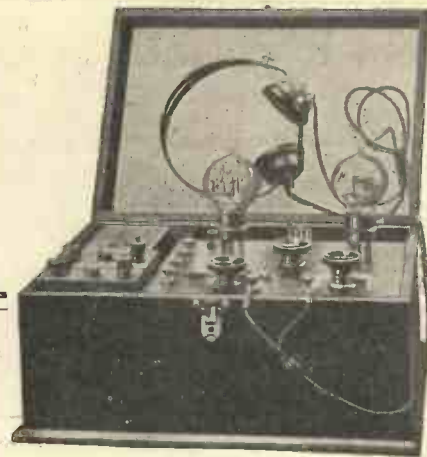

All on self-contained Radio 2 valve set.

Price 21 guineas

R.F.H.
BROADCASTING
INSTRUMENTS

If you are expecting perfect reception you MUST use R.F.H. RECEIVING INSTRUMENTS, R.F.H. 'PHONES, the MAGNAVOX or BROWN LOUD SPEAKERS.

We manufacture our own Components, Coils, Condensers, Resistances, Switches, etc., which not only enables us to ensure perfect Workmanship and Materials, but enables us to give quick delivery, and to offer guaranteed high quality Radio Goods at the lowest possible price.

All R.F.H. Receiving Instruments are made to fulfill the conditions laid down, and are accepted and passed by the Post-Master General for Broadcasting Reception, and are made under license. Prices range from 5 gns. to 100 gns. Exceptionally fine sets are purchasable from us or our agents at prices varying from 12 gns. to 35 gns., according to number of valves, etc., etc.

For super-excellence in reception and simplicity in operation, you must get an R.F.H. 2, 3, or 4 Valve Radio Set.

Buying Agents Wanted Everywhere.

Write to us for particulars. LISTS FREE.

Rogers, Foster & Howell
 LIMITED.

EDWARD ROAD, BALSALL HEATH,
 BIRMINGHAM.

R.F.H.
 Crystal
 Set
 (very fine
 reception)

PRICE
 £6/6/0



Radcom Rheostats

CONTROL, PROTECT, IMPROVE.

FEATURES:—Panel mounting $\frac{1}{2}$ to $\frac{3}{4}$ "
Positive Stops at zero and full
resistance. Single Turn Con-
trol. Smooth and Quiet.

GUARANTEED free from mechani-
cal or electrical faults and will be
replaced or repaired free if such defects
develop within six months of sale.

PLAIN TYPE for Amplifying
Valves 5/-

VERNIER TYPE for
Detector Valves .. 7/6
Ivory Scale 1/-



PLAIN
TYPE



Genuine Radcom Duo- lateral Inductance Coils

"DE FOREST PATENT"

These coils are designed to reduce
the self capacity of a receiving
inductance to a minimum.

PRICES—Mounted Complete, from
5/-

WRITE FOR CATALOGUE

RADCOM BATTERIES, TUNERS, TRANSFORMERS
AERIALS, ACCUMULATORS, INSULATORS.

ORDERS VALUE £2, NOT EXCEEDING 11-LBS. WEIGHT, CARRIAGE PAID.

Radio

COMPONENTS LTD.

19 Rathbone Place,
LONDON, W.1.

Telephone: Museum, 5261. Westcent, London.
Telegrams: Radponents,

WILTON WIRELESS OUTFITS AND PARTS

All Sets approved by the P.M.G.

Members of the

BRITISH BROADCASTING Co., Ltd.

Wilton No. 1 Outfit—
Cabinet Crystal Receiver, Hert-
zite Detector, 4000 ohm Phones,
Aerial Wire Insulators, etc.
£3/2/6
Plus B.B.C. royalty .. 7/6

£3/10/0
L.F. Intervalve Transformers 15/-

H.F. Broadcast Transformers 3/6
Set of 7 Basket Coils .. 4/6
Grid Leak and Condenser 2/6
Loud Speakers 2000 ohms 45/-

Note Magnifier—Set of Parts—
to make yourself, designed on
the "Radiocamo" principle,
loud signals when attached to
any make of receiver. Exceed-
ingly easy to make, Complete
with Cabinet and Instructions
£1/17/6

Making a 3 guinea instrument.
Fixed Condensers .001 & .002 2/6

Wilton No. 2 Outfit—
Cabinet Valve Receiver, Tapped
Inductance, 4000 ohm Phones,
Valve H.T. Battery, Accumula-
tor, Aerial Fittings and Instruc-
tions, Designed by experts for
Telephony. Price .. £8/17/6
Plus B.B.C. and Marconi
royalties 1/12/6

£8/10/-
Skeleton Variable Condensers—
.0003 .0005 .001
8/- 10/- 16/6

Switch Arms, Laminated 2/-
Velvet Filament Rheostats 3/-
3 Coil Holders 10/6
Tapped Inductance Coils, 300-
900 metres, 9 tappings 7/6
Ivory Scales 8d.
Engraved Dial and Knob 3/6
Enclosed Crystal Detector, Ball
action, Hertzite Crystal 4/9

GET OUR 14-PAGE LIST—TRADE SUPPLIED.

Wilton Wireless Co., Ltd.

120/124, High Street, Tooting, S.W.17.

Phone: Streatham 533.

FILTRONS

Patented

Eliminate ENÆMICS and DISTORTION by using a VARIABLE GRID LEAK

Refinement in the reception of Radio Telephony neces-
sitates extreme critical control of the Grid potential.

The accumulations of electrons on the grid must be
definitely filtered away in precise Syncopation with
the input modulations to ensure purity of conversion
from Radio to Audio frequency.

You will be astounded by the improvement.

5/- VARIABLE GRID LEAK 5/-

Post Free to
any part of
the U.K.

Post Free to
any part of
the U.K.

Postal Orders and Cheques to be crossed and made payable to:—

RADIO SPECIALITIES

57a - Denbigh Street
PIMLICO - - S.W.1

Terms:—Cash with order.

Generous
Terms to
Manufact-
urers and
Traders.

Special
Terms to
Exporters
for
quantities.

YOU—an Advertiser

are reading this. You are not alone. At
least 100,000 other wireless enthusiasts
have spent a shilling to buy "MODERN
WIRELESS." These 100,000 and their
friends will read any announcement you make
in "MODERN WIRELESS." You will find
it the most economical method of advertising
your goods or service. For £25 0 0 you can
command the attention of at least 100,000
readers. Your advertisement will be read
and re-read time after time during the
course of a whole month. It is not seen
to-day and forgotten to-morrow.

A large space in a monthly journal is the most
economical method of advertising. For
£25 0 0 or pro rata for smaller spaces, you
reach the best type of prospective customer.
You have a very large page in which to
display your matter to the best advantage.
The paper on which your announcement is
made is of the finest quality.

Please communicate with our Advertisement Managers:—

Scheff Publicity Organisation Ltd.

125 PALL MALL, LONDON, S.W.1

Just Published

**WIRELESS HANDBOOK
AND DIARY 1923.**

Edited by Paul D. Tyers.

Everyone needs a Diary. This one is ideal for the wireless worker, particularly the experimentalist.

Make sure you get the title right.

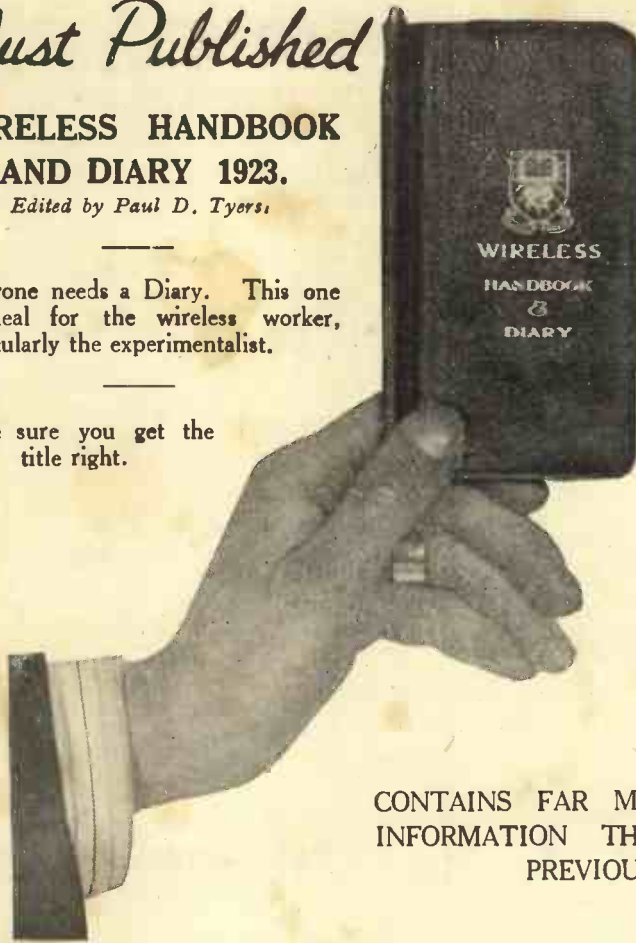

**A COMPLETE LETT'S
DIARY**

with 40 pages of
GENERAL INFORMATION
and 40 pages of
WIRELESS INFORMATION

HANDSOMELY BOUND IN
REAL LEATHER.

Contains good quality pencil,
special self-opening memo tablet
and £1,000 insurance policy.

CONTAINS FAR MORE PAGES OF WIRELESS
INFORMATION THAN ANY OTHER DIARY
PREVIOUSLY PUBLISHED.

A WIRELESS DIARY AT THE PRICE OF AN ORDINARY DIARY!

PRICE 2/6 NET.

(Post Free 2/8)

As regards the quality of the production, we have only to mention the name of Charles Letts. As regards the authoritative and useful character of the wireless information it is only necessary to remind you that it has been prepared by the technical staff of Radio Press Ltd.

CONTENTS.

Valve Data—General Notes—Filament Batteries—Condenser Valves—Resistances—Morse Code—Charging Accumulators—Conventional Signs used in Wireless Diagrams—Practical Units used in Electrical Work—Electrical Units—Electrical Data—High power Land Stations easily audible in Great Britain—Abbreviations used in Wireless—Practical Circuits for Reception and Transmission (10 pages)—Approximate Turns per inch of Insulated Wires—Inductance of Air Core Solenoid—Nagaoka's Correction Factor—Sizes of Standard Wire Gauge—Condenser Capacities—Table of Specific Inductive Capacities—Data for Resistance Wires—Approximate Aerial Data—Additional Call Signs.

Quarter Days, Calendar notes for five years—Calendars for 1923, 1924—Sun 1923—Moon 1923—Postal Information—Eclipses—Bank Holidays—Law Sittings—University Terms—Holidays at Public Offices—Taxes, Licences, and Stamp Duties—Abbreviations—Weights and Measures—Metric Equivalents—Foreign Currency Table—Area and Population of Foreign Countries—Population of Principal Towns—Time in Principal Cities and Towns—First Aid—Antidotes for Poisons—London Amusements—Sporting Information and Records—Daily Wants Dictionary—Gardening Calendar—Personal Memoranda—Memoranda—Diary Pages—Memoranda—Addresses—Insurance Form.

AND ALL THIS IS YOURS FOR HALF-A-CROWN!

Order at once through your Bookseller or send 2/8 to:

Radio Press Ltd., Devereux Buildings, Devereux Court, Strand, W.C.2.

USE THIS POST CARD

If you are interested in any of the announcements
of the Advertisers in this issue.

THIS POST CARD is intended to save

Time and Money

When enquiring for special particulars or a catalogue from an Advertiser, use this card. It will ensure you prompt attention. The advertiser will see the value of advertising in your magazine and the increased revenue to the proprietors will ensure the improvement month by month of "Modern Wireless."

Use this card whether you send an order or merely an enquiry.

A UNIQUE SCHEME

You can save a great deal of time, money and trouble if you address the post card to:—

SCHEFF PUBLICITY ORGANISATION LTD.
125, Pall Mall, LONDON, W.1

our Advertising Managers. On the front of the card put down all the names of the advertisers whose catalogues you would like to have, enclosing postage only where necessary. If special particulars are desired, name them, Scheff Publicity Organisation Ltd. will see to the rest. Your expense is one half-penny!

SEND THE POST CARD AT ONCE!